

Section view A-A

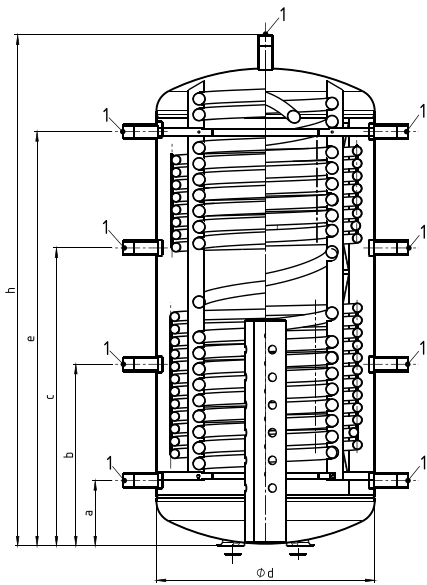

Section view B-B

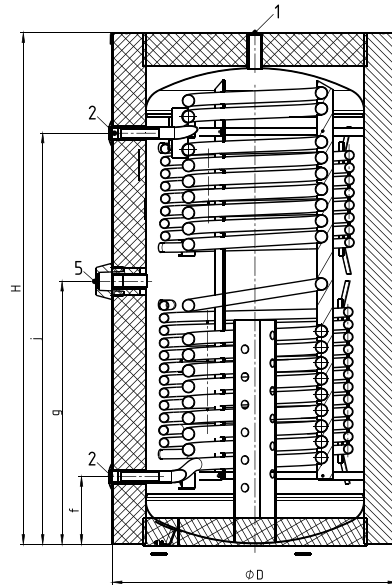

Section view C-C

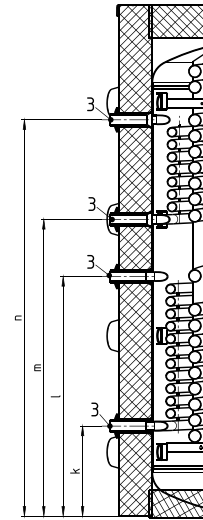

Section view E-E

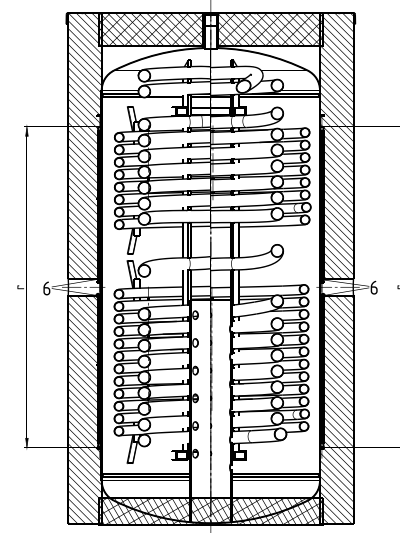

D	1028 mm
H	2142 mm
a	310 mm
b	768 mm
c	1228 mm
d	790 mm
e	1681 mm
f	249 mm
g	1068 mm
h	2135 mm
j	1774 mm
k	330 mm
l	870 mm
p	110 mm

1	G 1 1/2"
2	G 1 1/4"
3	R 1 1/4"
4	R 1 1/4"
5	G 1 1/2"

1	Innengewinde
---	--------------



Thinking solutions.

Section view D-D

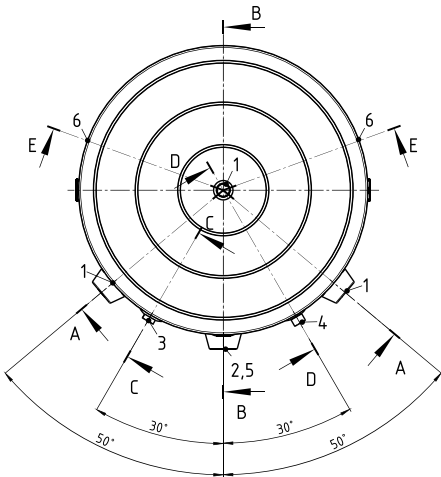
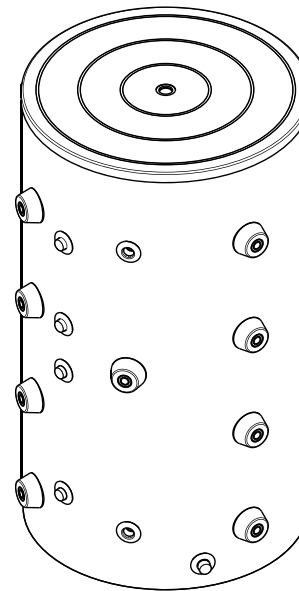
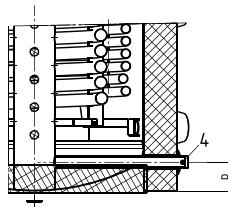

Unterliegt nicht dem Änderungsdienst / Not subject to change management	Maßstab / Scale: unmaßstäblich unmeasured	Format / Size: A4
Revision 19/06/2026	Storatherm Heat Combi HC 1000/1_C silber – Pdf_drawing_7859400	