

Side view

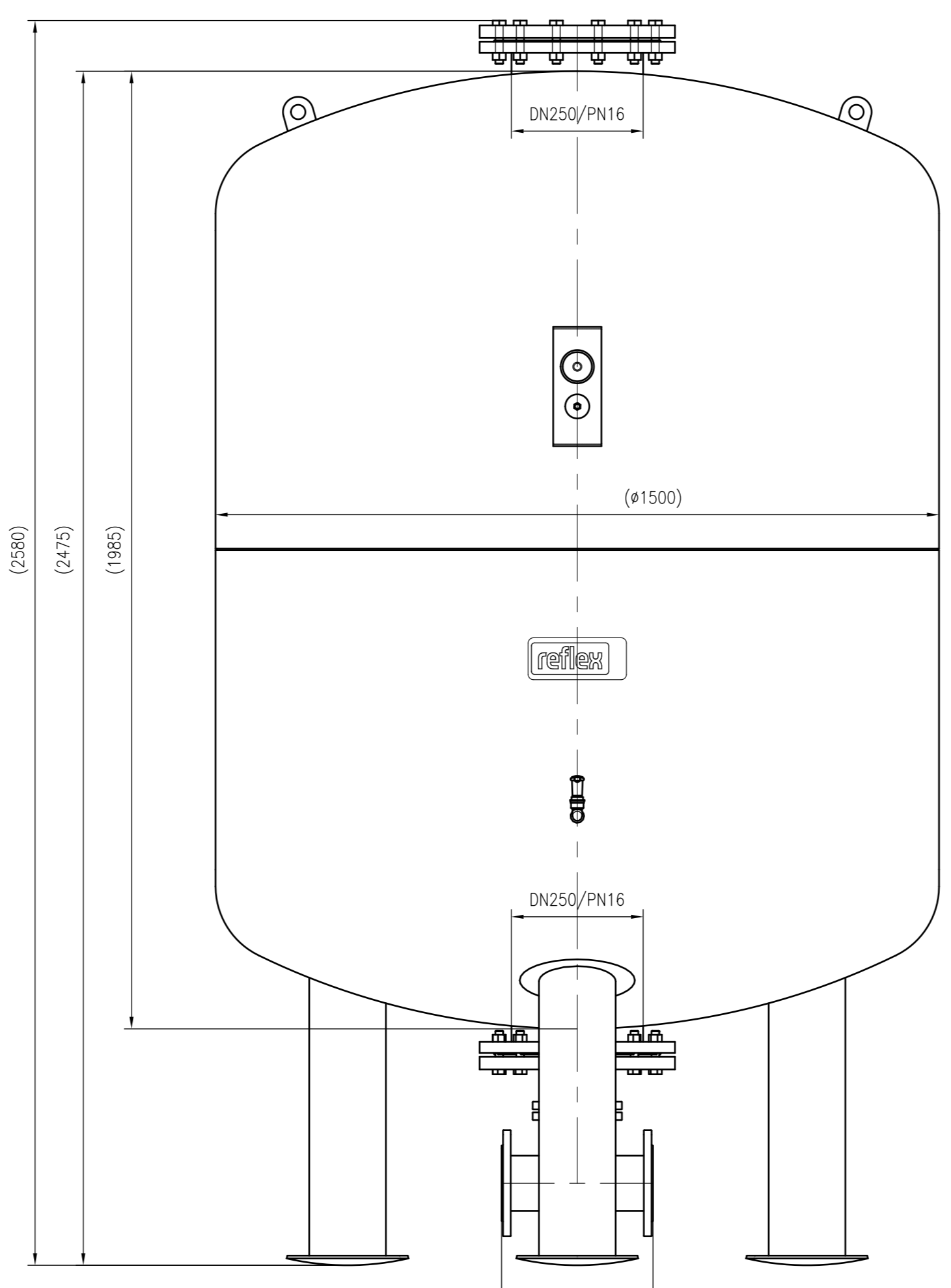

Front view

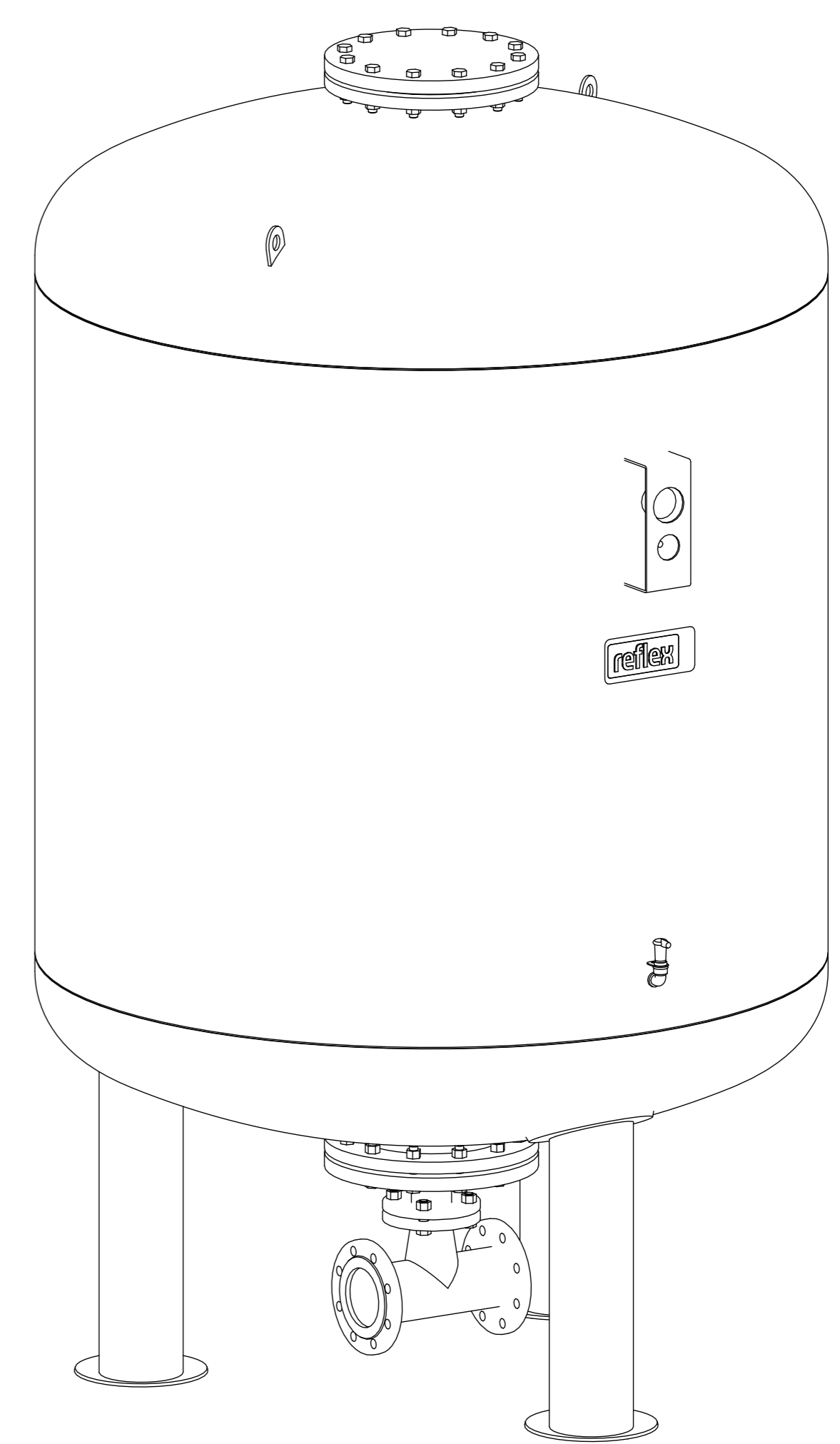

Isometric view

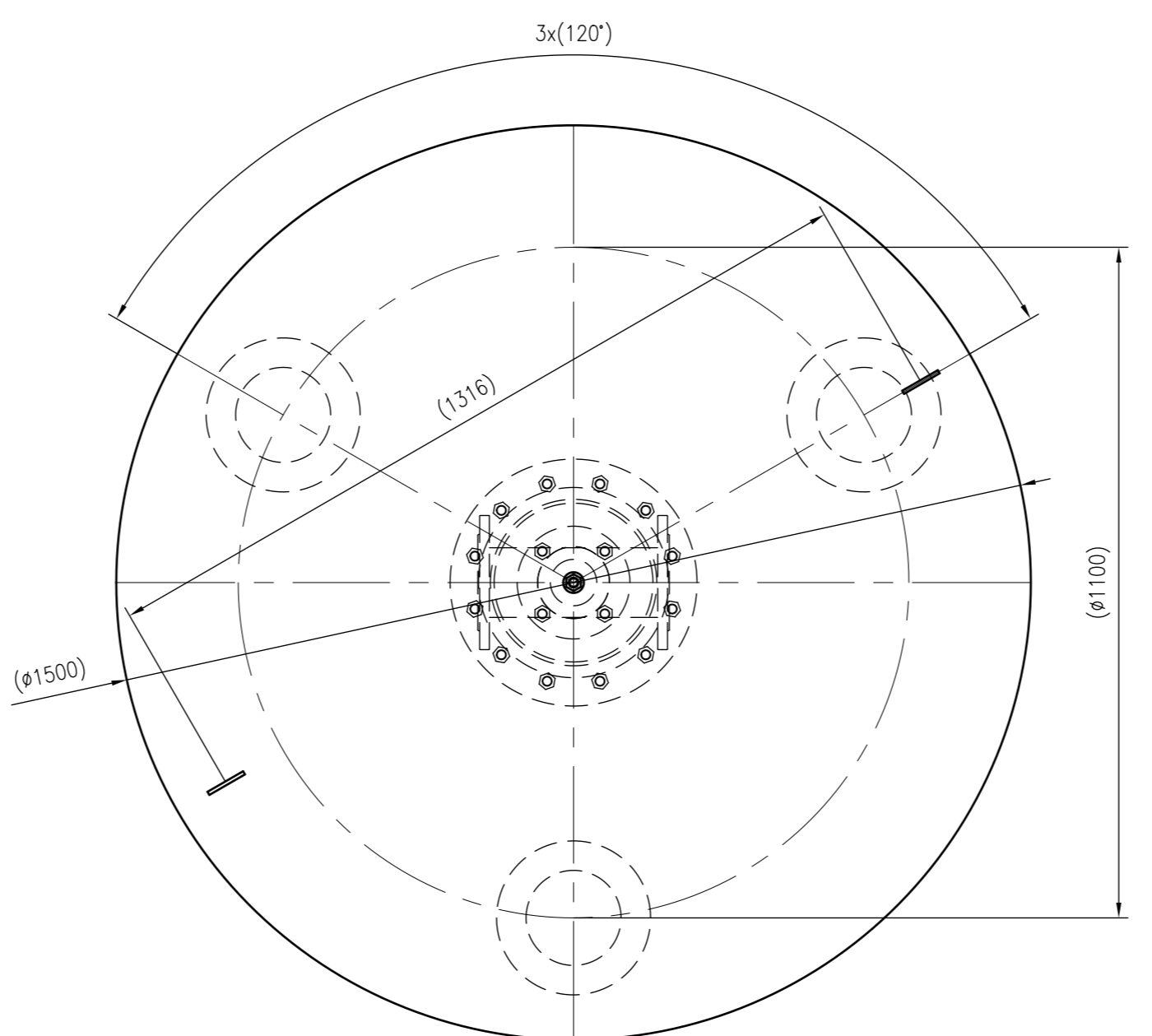

Top view

Membranbruchmelder
nur auf Kundenwunsch/
bladder rupture detector
only on customer request



Unterliegt nicht dem Änderungsdienst/ Not subject to change management		Maßstab/ Scale: 1:10	Format/ Size: A1
Revision 04.05.2016	Refix DT 3000 16bar – 7340405		