

Side view

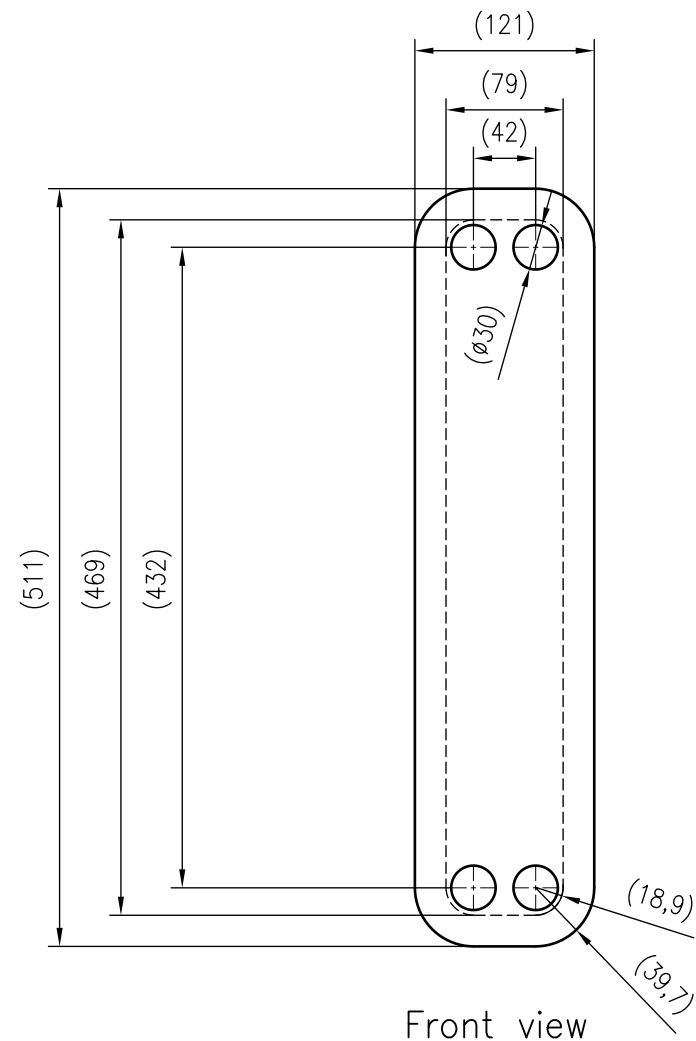

Front view

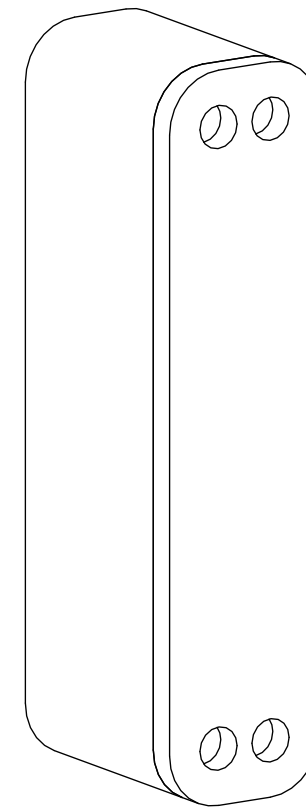

Isometric view

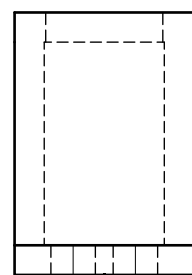

Top view



Unterliegt nicht dem Änderungsdienst/ Not subject to change management		Maßstab/ Scale: 1:5	Format/ Size: A3
Revision 04.05.2020	Longtherm Protect Cooling R...B-34-8296300		