

Side view

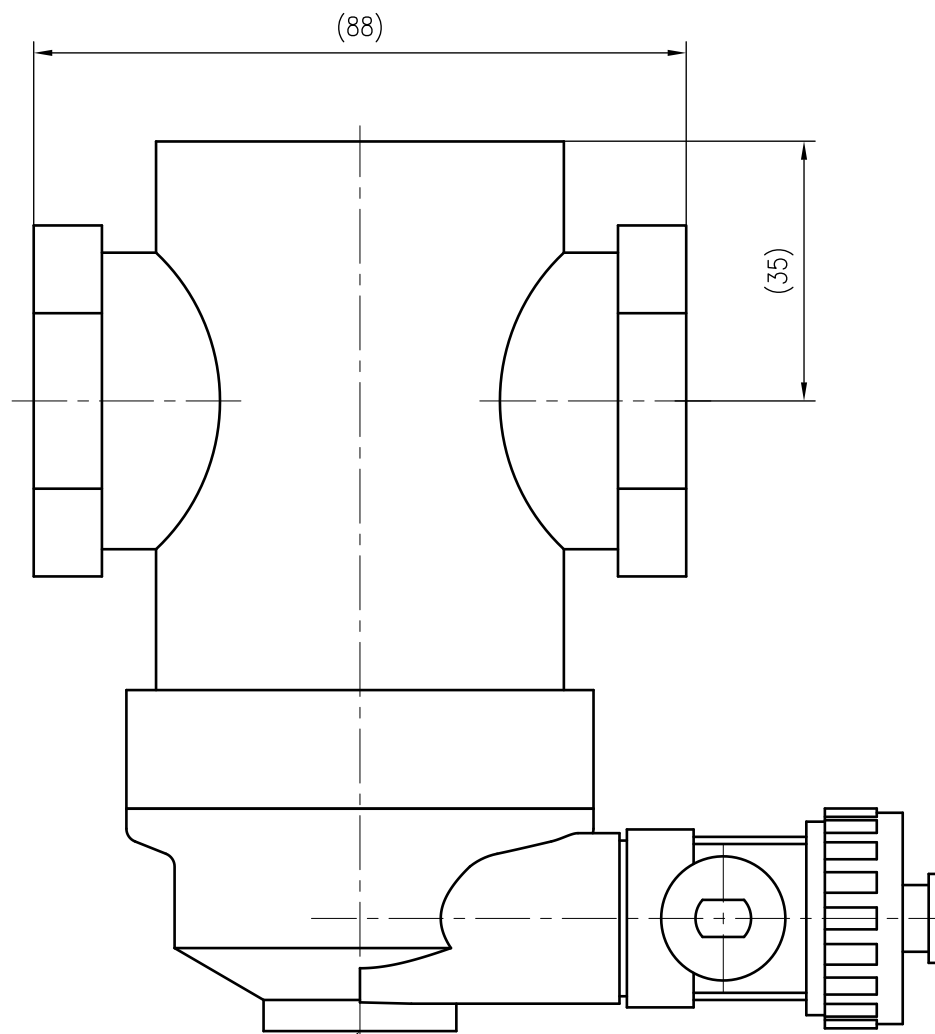

Front view

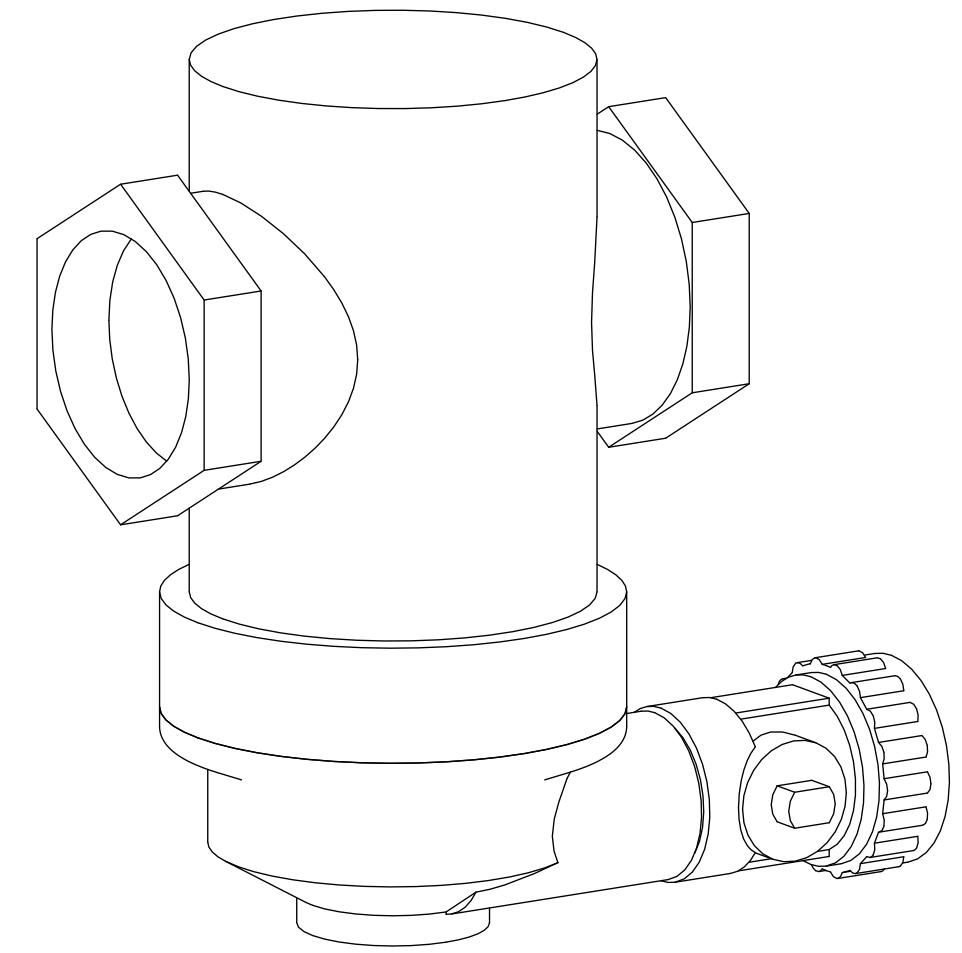

Isometric view

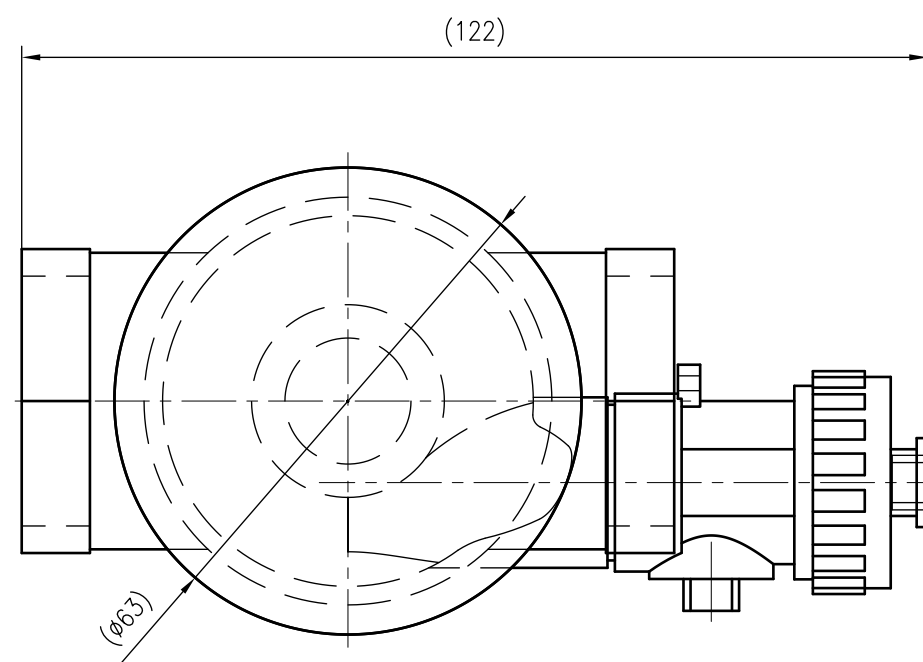

Top view



Unterliegt nicht dem Änderungsdienst/ Not subject to change management	Maßstab/ Scale: 1:1	Format/ Size: A2
Revision 23.08.2018	Exdirt D1 – 9252020	