

Section view A-A

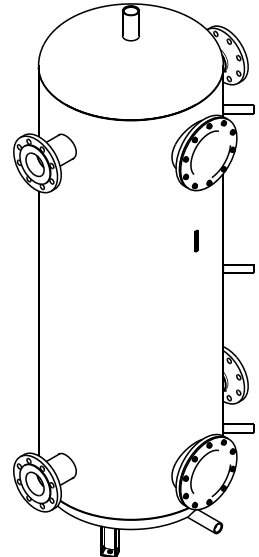

Darstellung ohne Isolation/
Shown without isolation

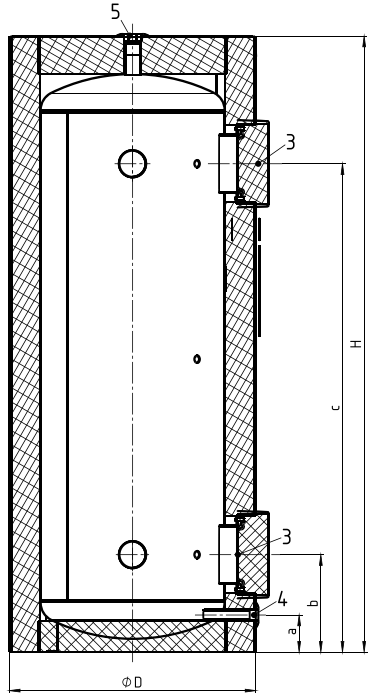
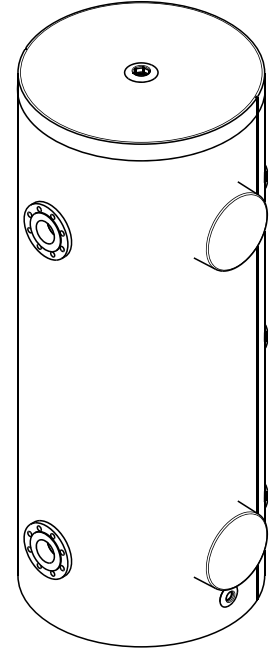
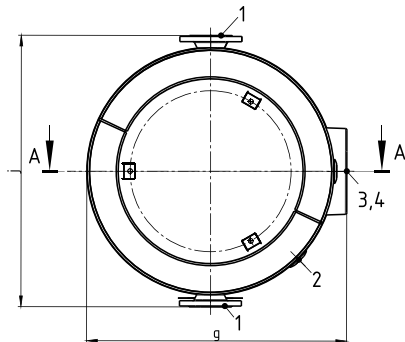
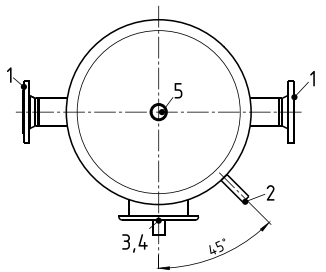

a	120 mm
b	315 mm
b	315 mm
c	1578 mm
c	1578 mm
c	1578 mm
d	597 mm
e	947 mm
g	839 mm
h	1969 mm
j	874 mm

1	DN80/PN16
2	G 1/2"
3	DN180
4	G 1"
5	G 1 1/2"

1	Flansch
---	---------



Thinking solutions.

Unterliegt nicht dem Änderungsdienst / Not subject to change management	Maßstab / Scale: unmaßstäblich unmeasured	Format / Size: A4
Revision 19/06/2026	Storatherm Heat H 500/R2 grau – Pdf_drawing_7351700	