

Section view A-A

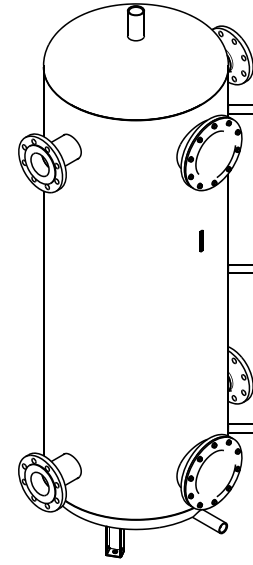

Darstellung ohne Isolation/
Shown without isolation

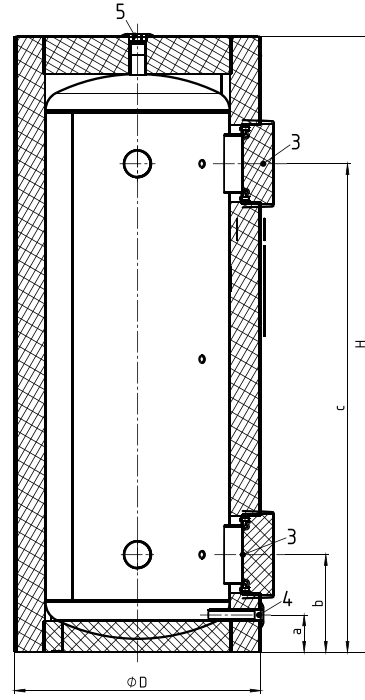
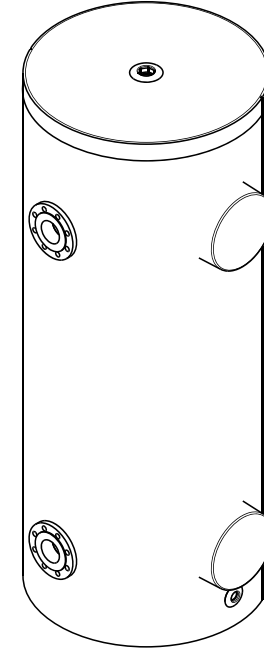
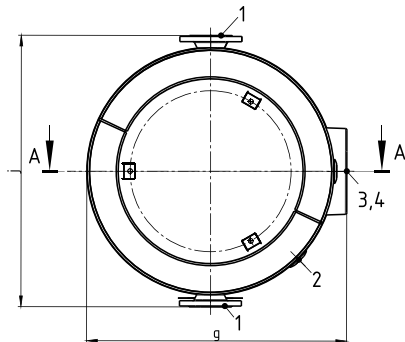
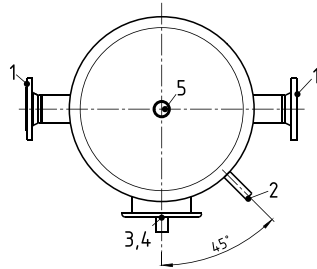

a	135 mm
b	352 mm
b	352 mm
c	1686 mm
c	1686 mm
c	1686 mm
d	790 mm
e	1038 mm
g	1025 mm
h	2215 mm
j	1074 mm

1	DN125/PN16
2	G 1/2"
3	DN180
4	G 1"
5	G 1 1/2"

1	Flansch
---	---------



Thinking solutions.

Unterliegt nicht dem Änderungsdienst / Not subject to change management	Maßstab / Scale: unmaßstäblich unmeasured	Format / Size: A4
Revision 19/06/2026	Storatherm Heat H 1000/R2 grau – Pdf_drawing_7351900	