

Side view

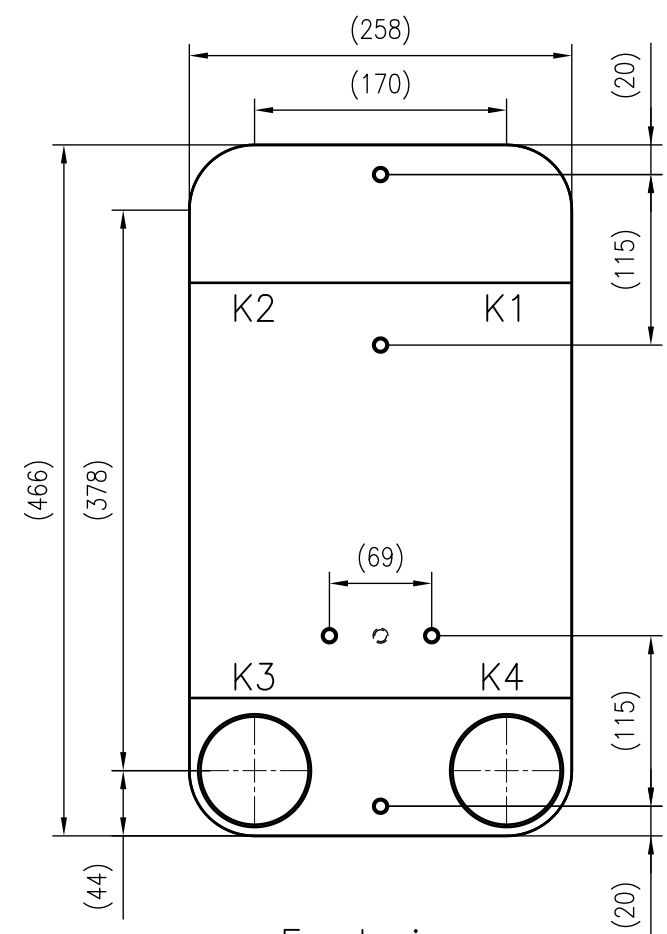

Front view

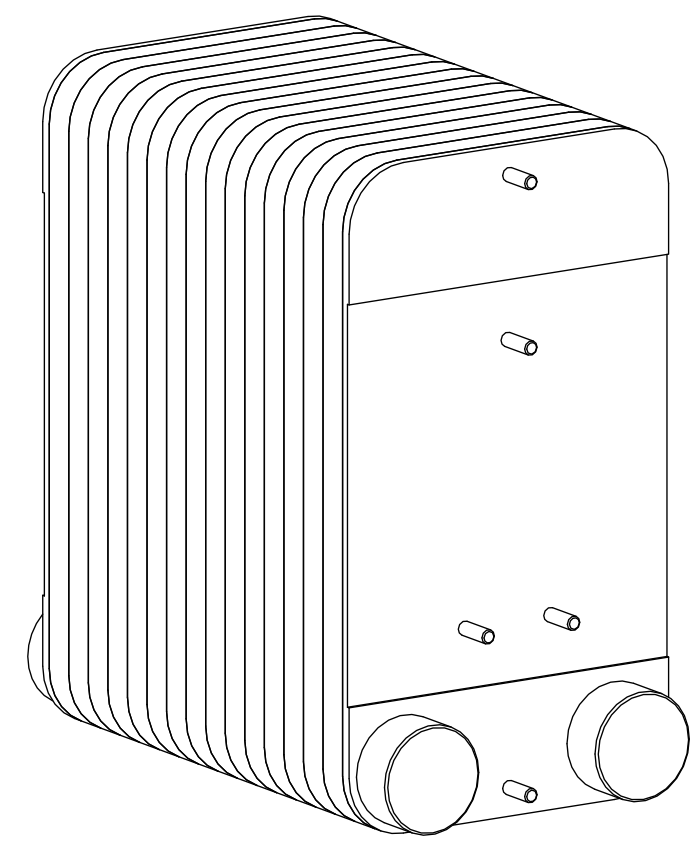

Isometric view

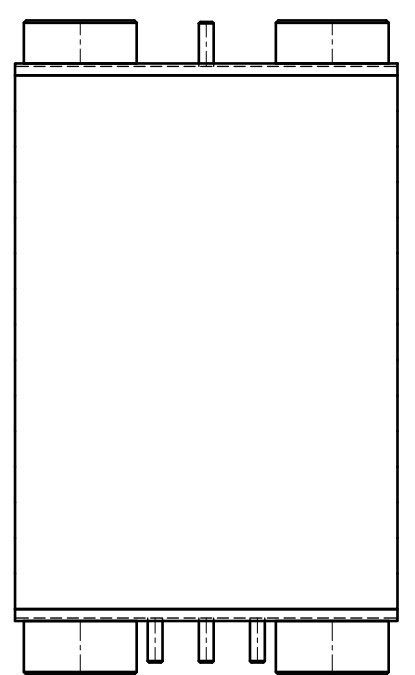

Top view



Unterliegt nicht dem Änderungsdienst/ Not subject to change management		Maßstab/ Scale: 1:5	Format/ Size: A3
Revision 27.08.2020	Longtherm RMB-110-2-150-P25 - 8048500		