

Side view

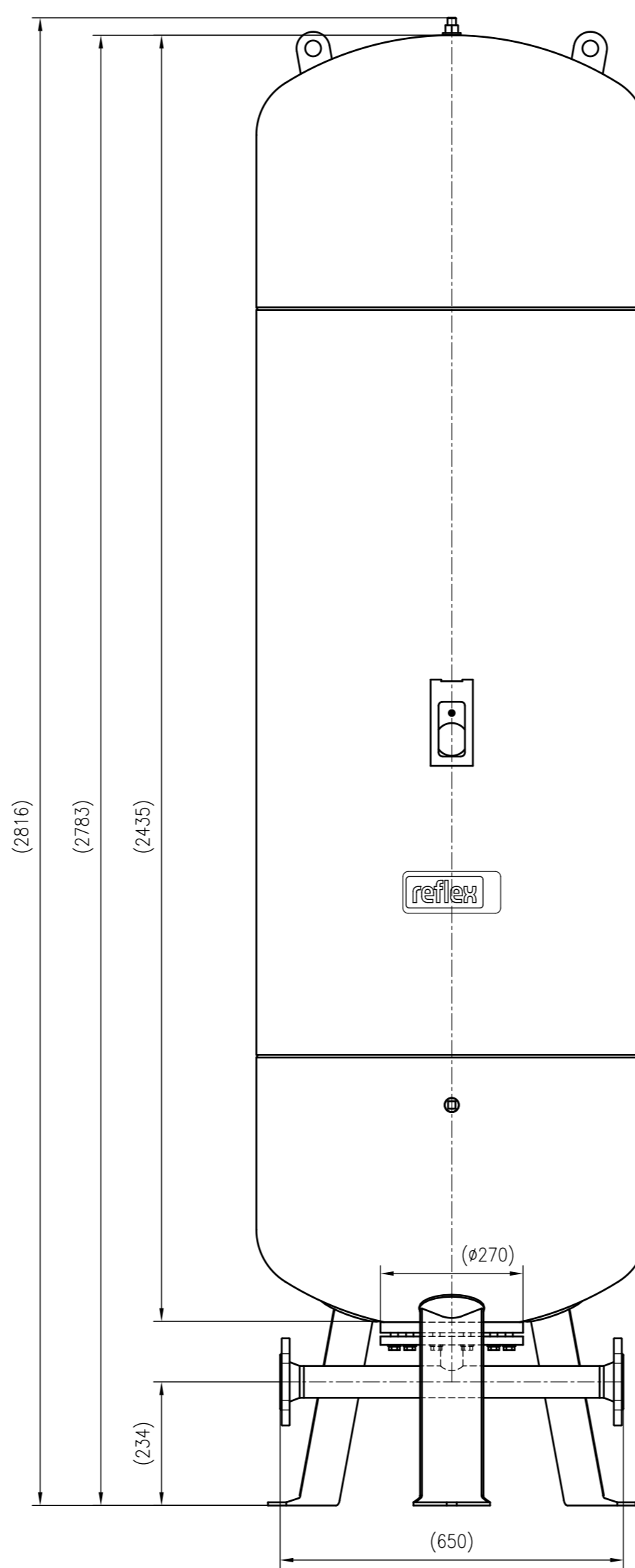

Front view

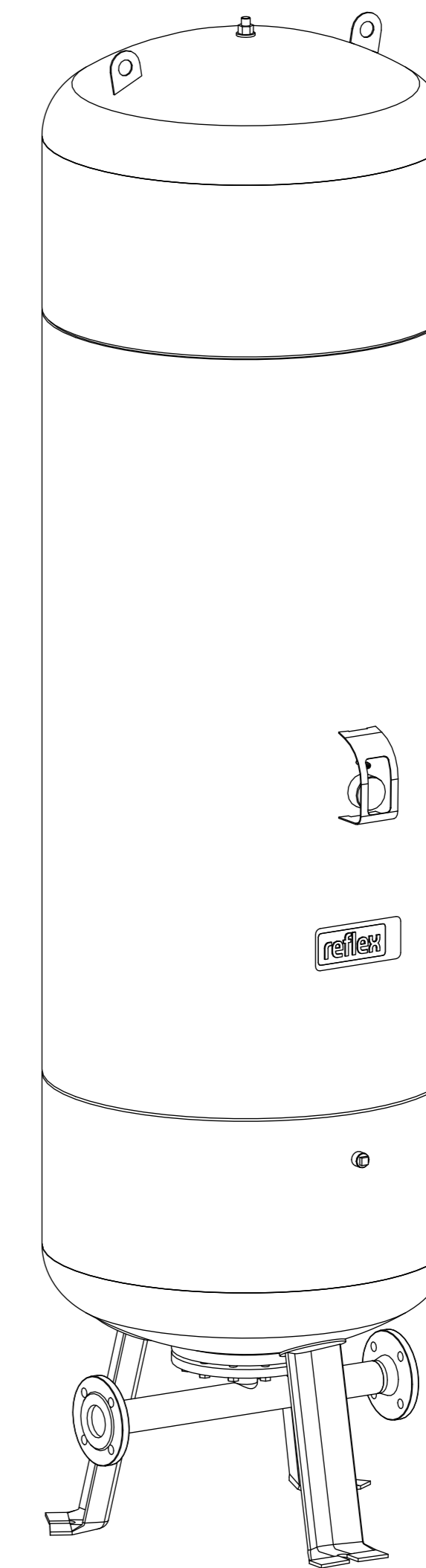

Isometric view

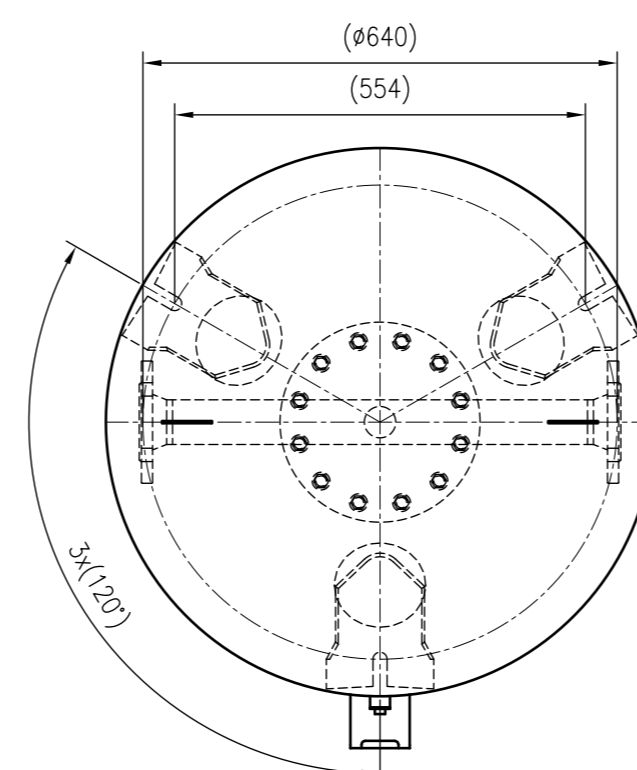

Top view



Unterliegt nicht dem Änderungsdienst/ Not subject to change management		Maßstab/ Scale: 1:10	Format/ Size: A1
Revision 22.04.2026	Refix DT 1000 (740mm) 16bar – 7370800		
			A1