

Side view

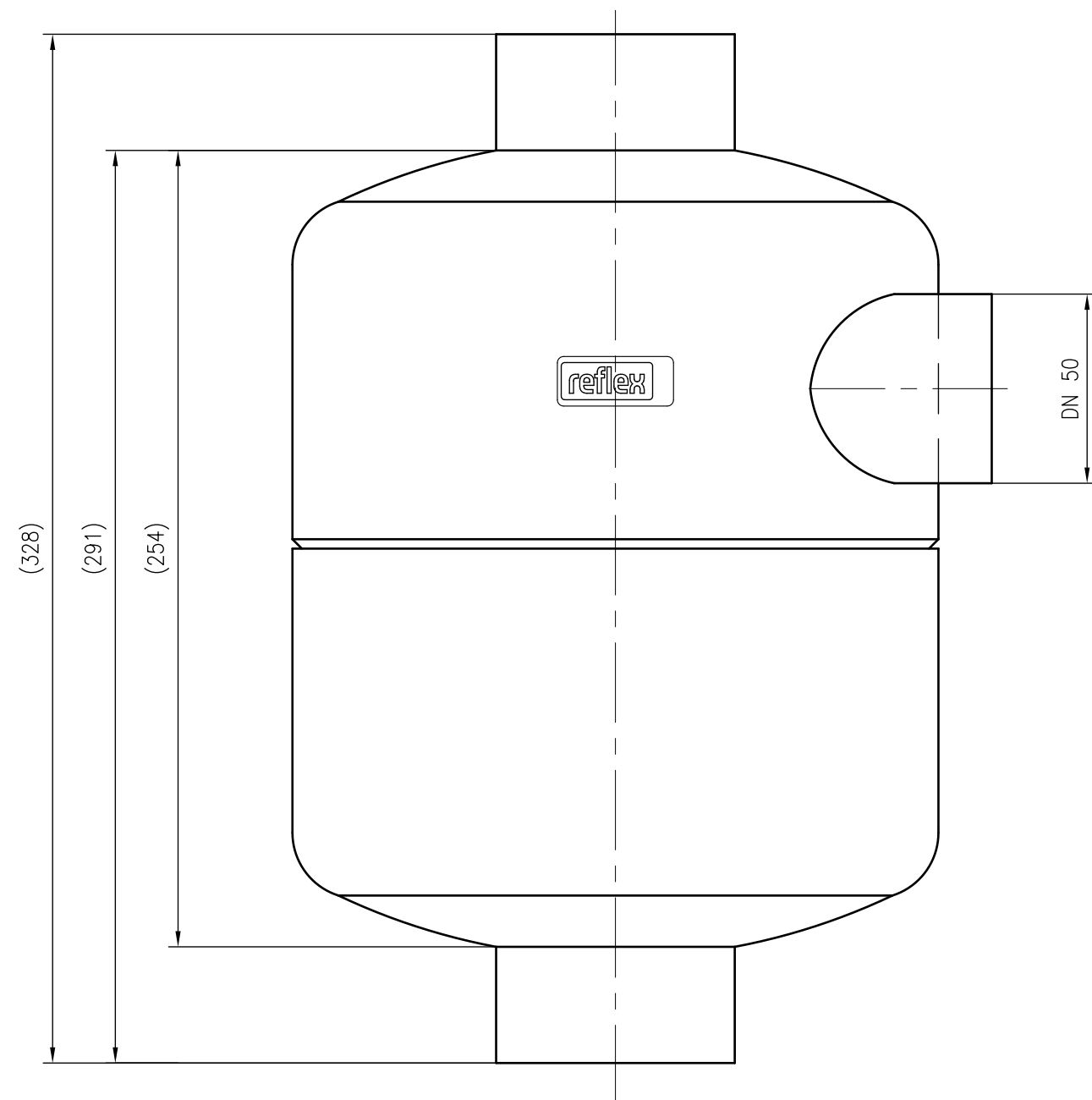

Front view

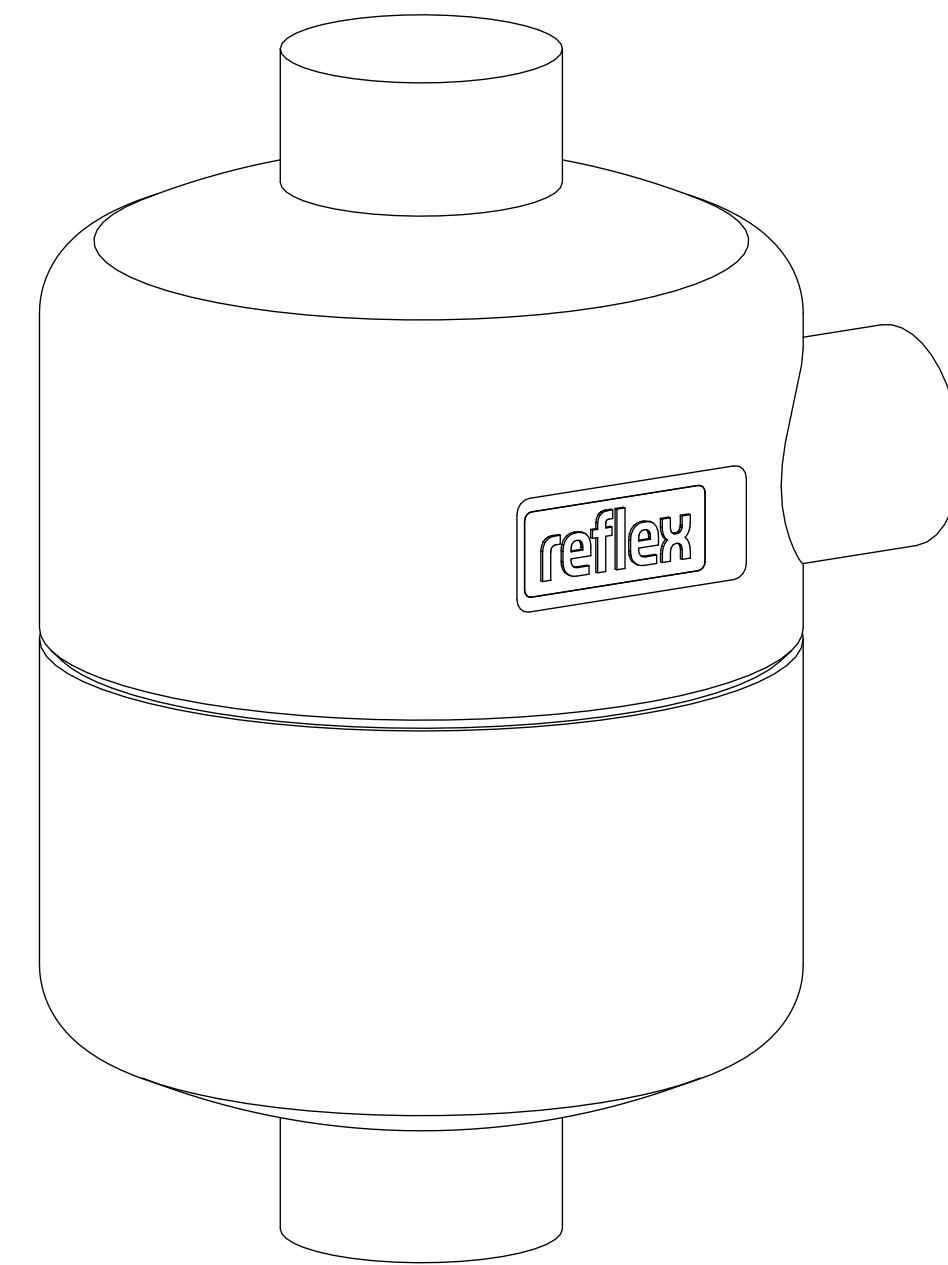

Isometric view

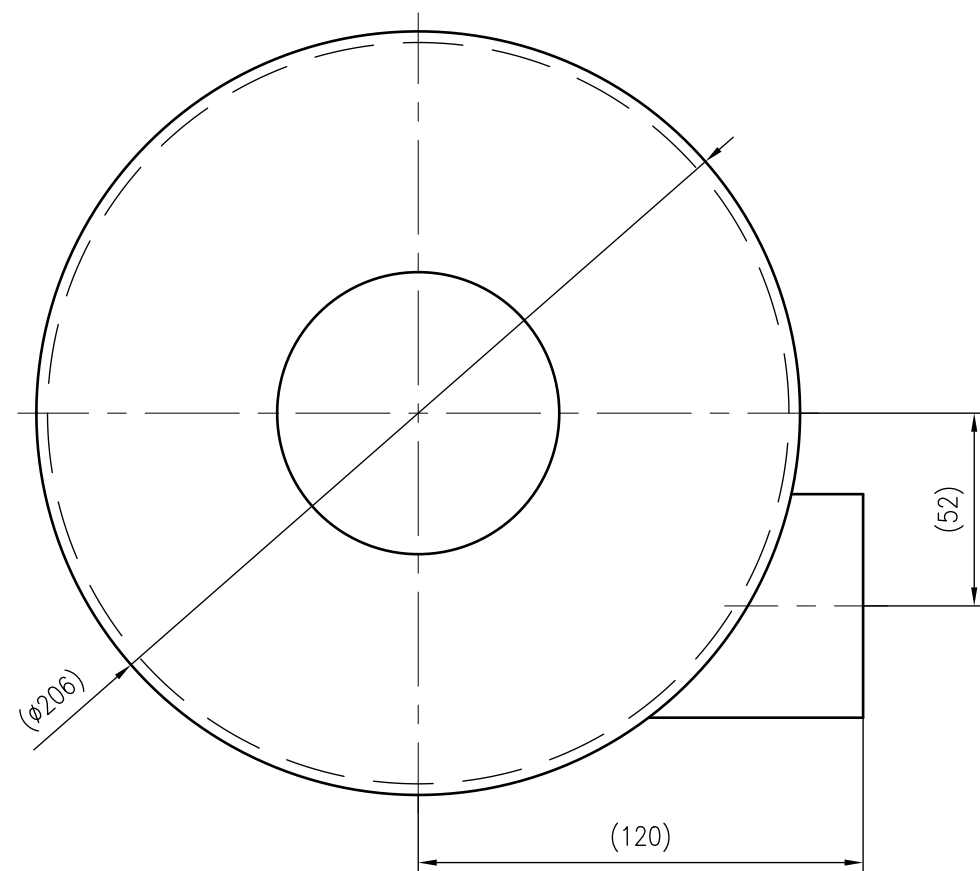

Top view



Unterliegt nicht dem Änderungsdienst/ Not subject to change management	Maßstab/ Scale: 1:2	Format/ Size: A2
Revision 19.05.2016	Expansion trapf T170 – 8680000	