

Side view

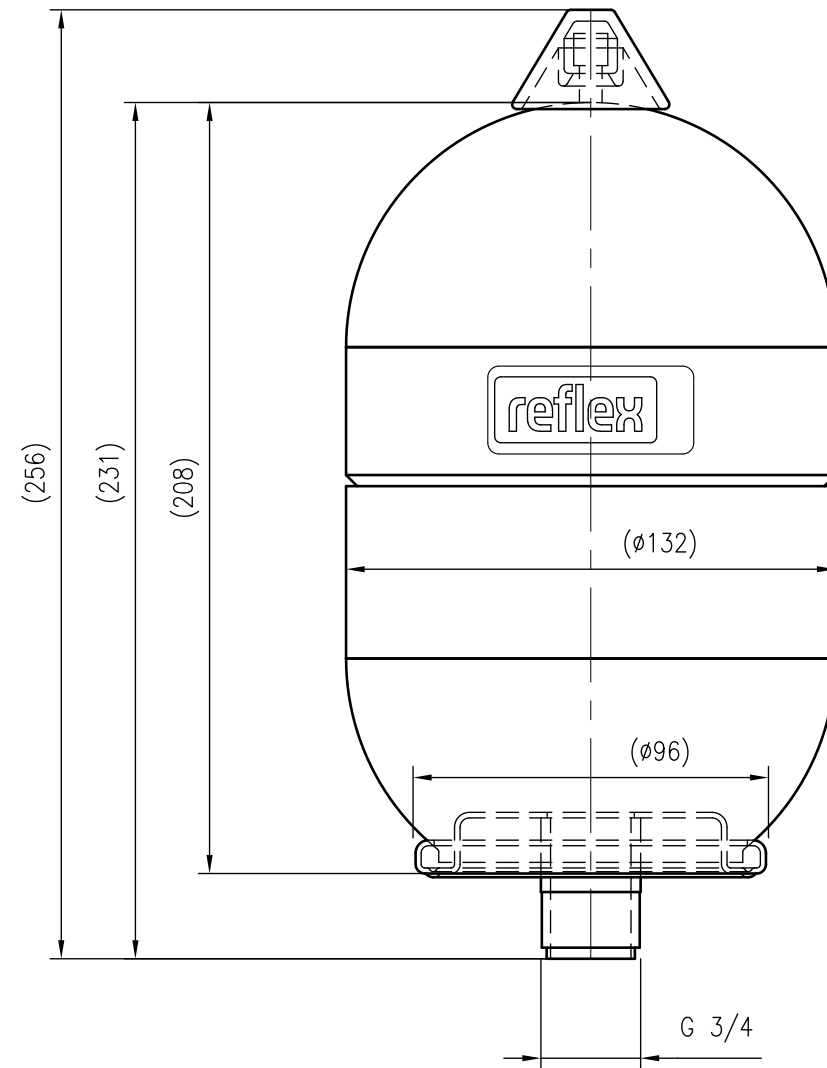

Front view

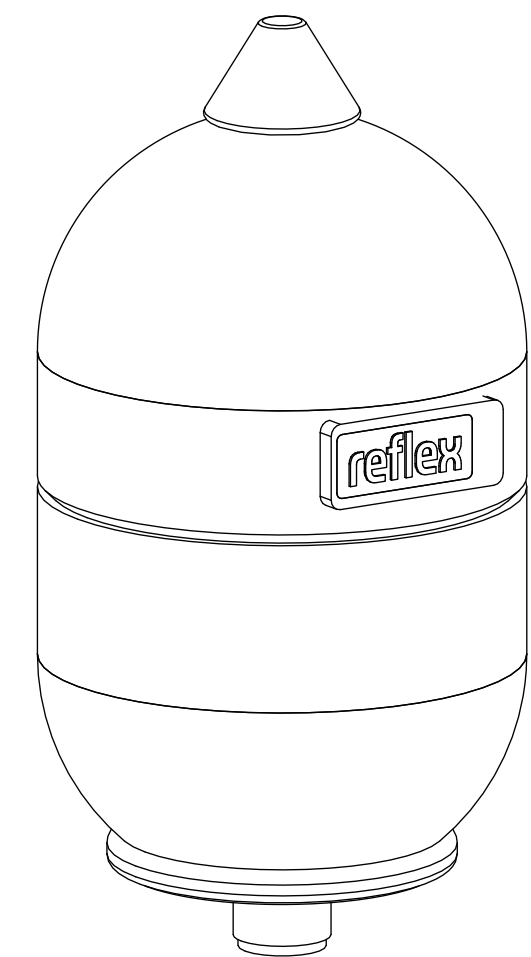

Isometric view

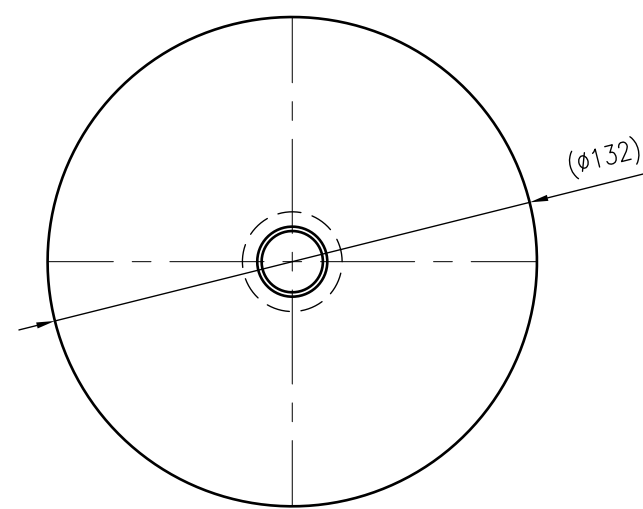

Top view



Unterliegt nicht dem Änderungsdienst/ Not subject to change management	Maßstab/ Scale: 1:2	Format/ Size: A2
Revision 20.06.2023	Refix DE 2 10bar – 7200300	