

Side view

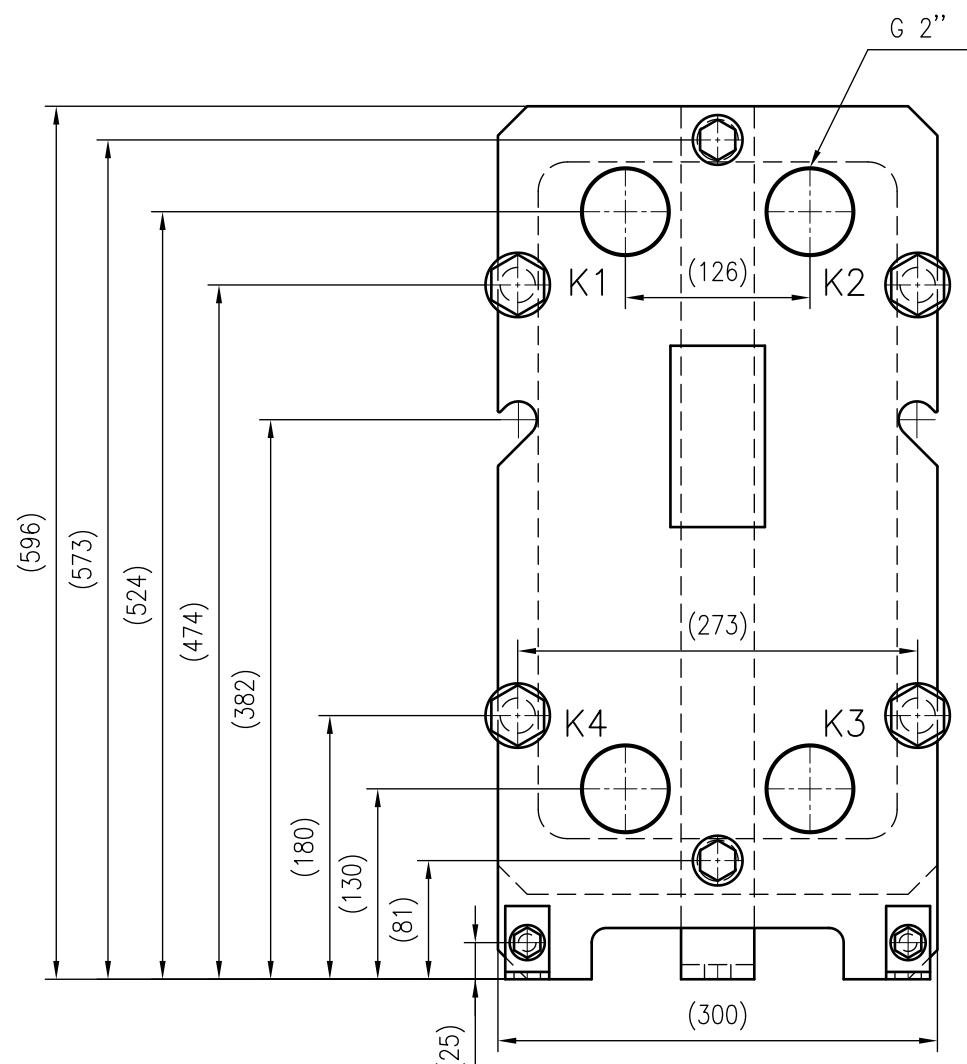

Front view

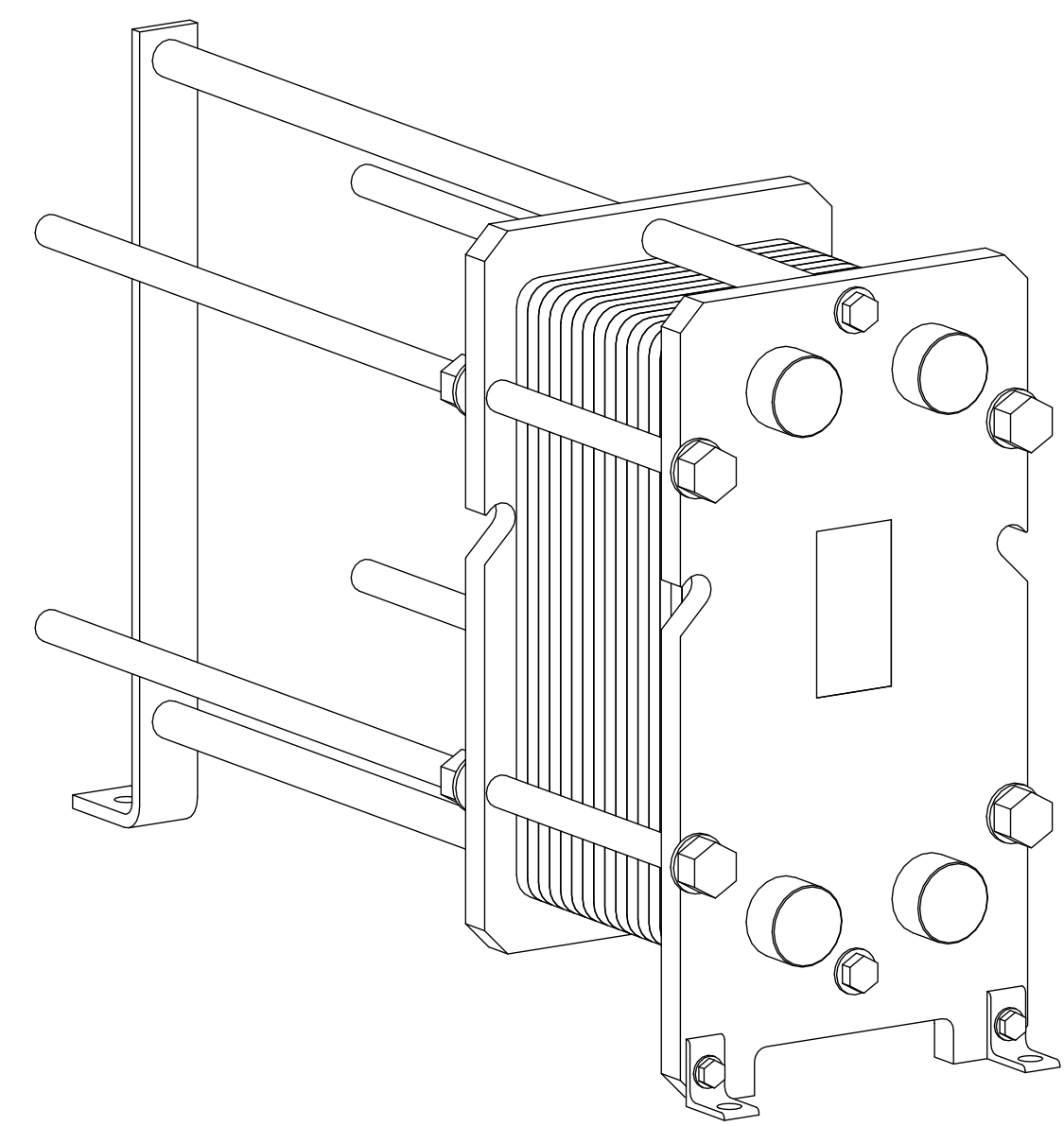

Isometric view

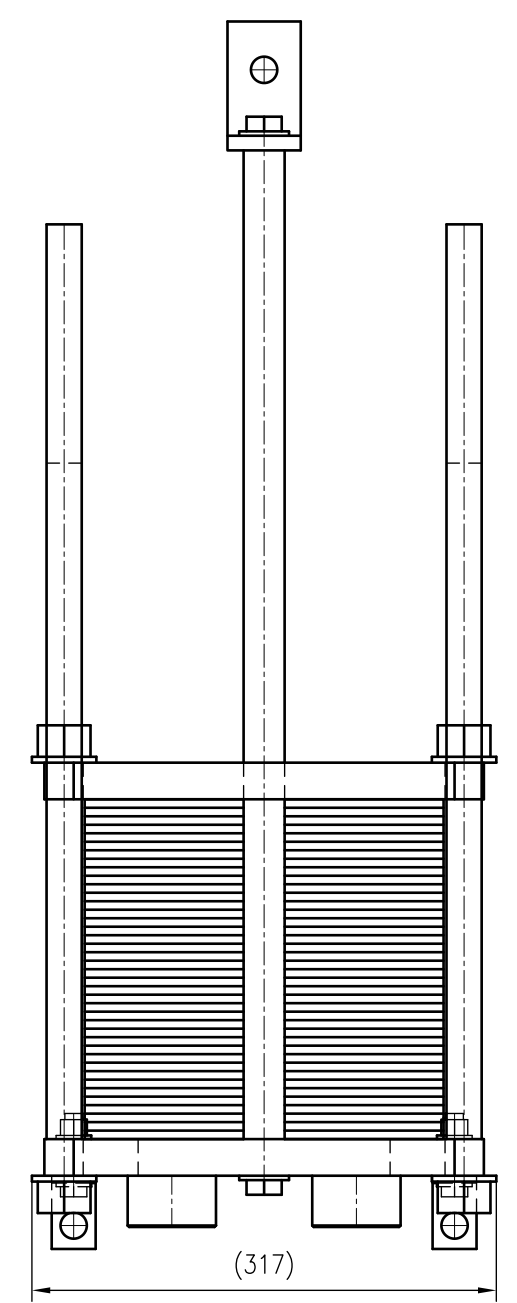

Top view



Unterliegt nicht dem Änderungsdienst/ Not subject to change management	Maßstab/ Scale: 1:5	Format/ Size: A2
Revision 27.07.2020	Longtherm RMG-07-80-P16 - 8122300	