

Side view

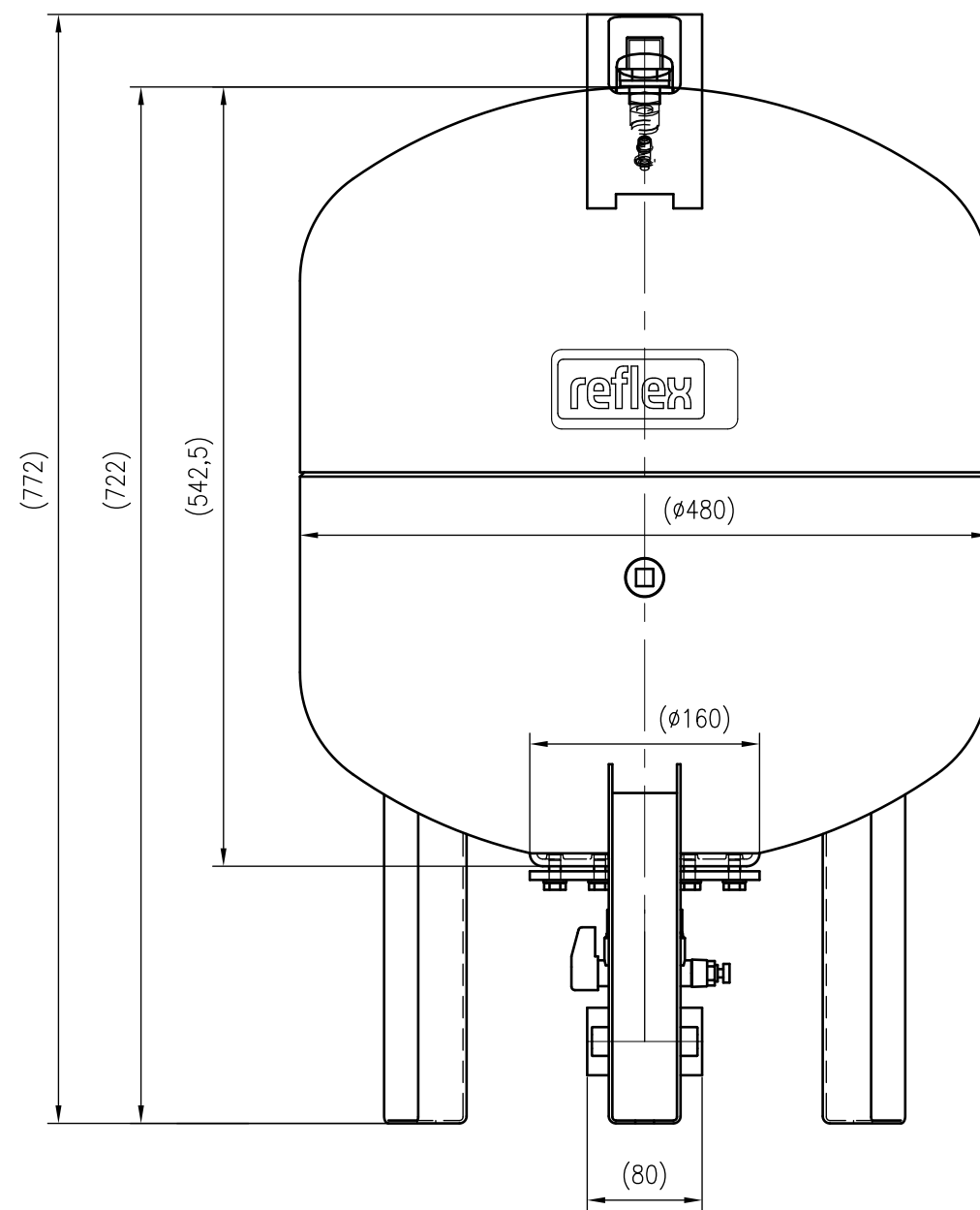

Front view

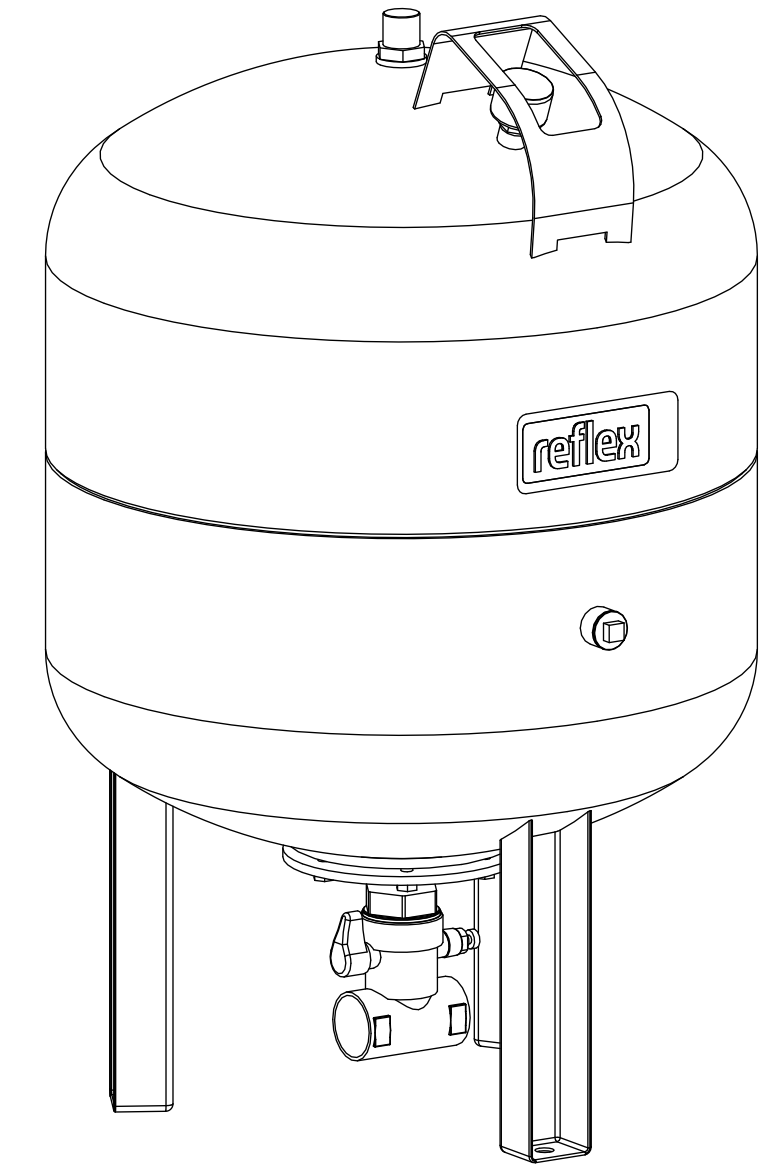

Isometric view

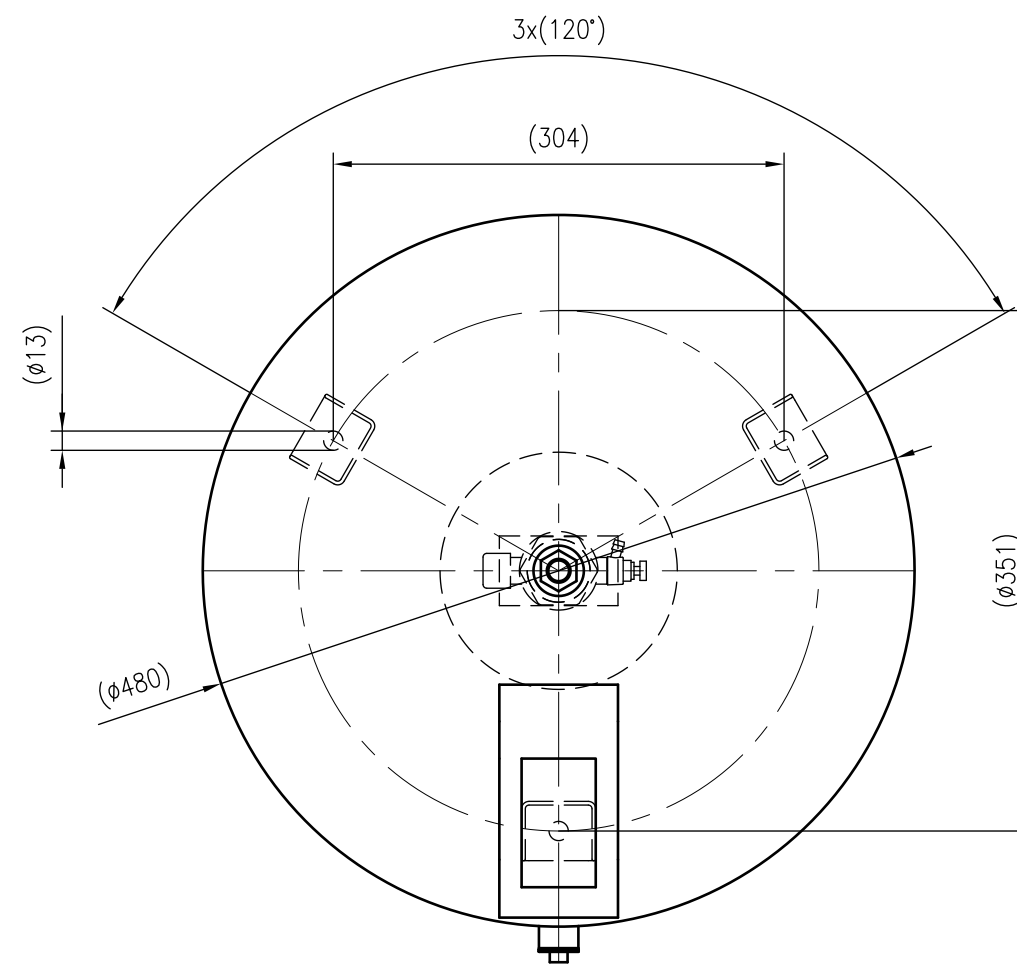

Top view



Unterliegt nicht dem Änderungsdienst/ Not subject to change management	Maßstab/ Scale: 1:5	Format/ Size: A2
Revision 08.07.2022	Reflex DT 80 10bar – 7309100	