

Side view

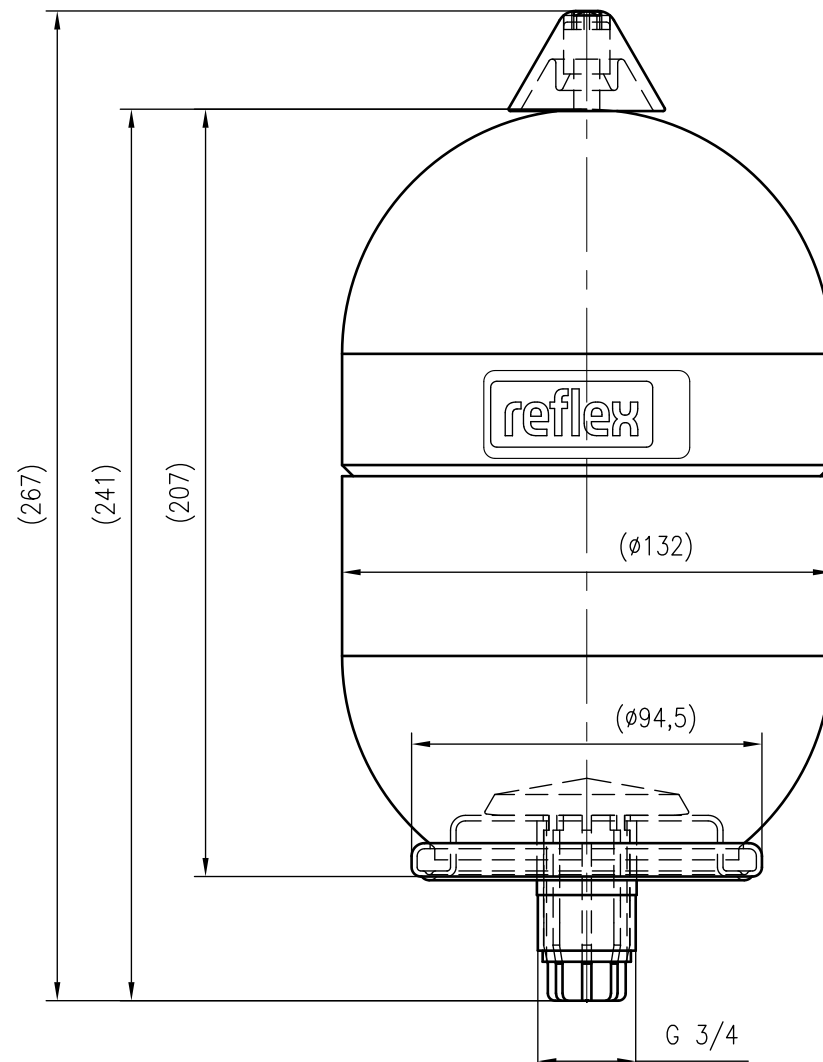

Front view

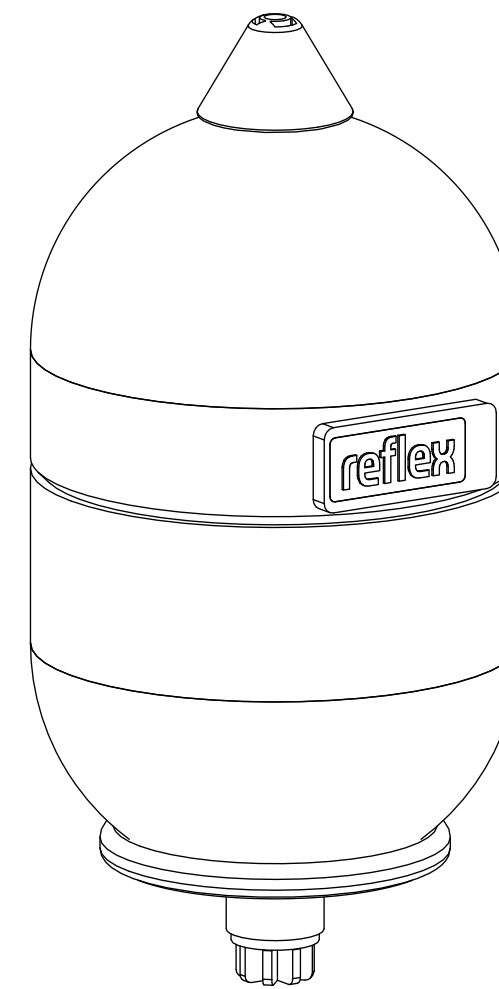

Isometric view

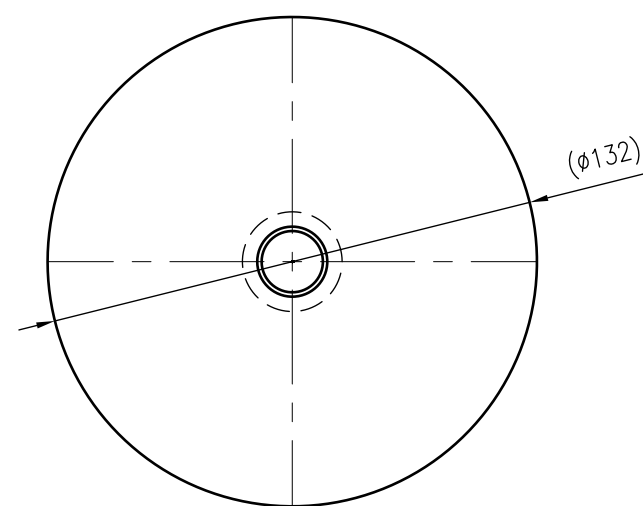

Top view



Unterliegt nicht dem Änderungsdienst/ Not subject to change management		Maßstab/ Scale: 1:2	Format/ Size: A2
Revision 12.01.2023	Refix DD 2 10bar green – 7381500		