

Side view

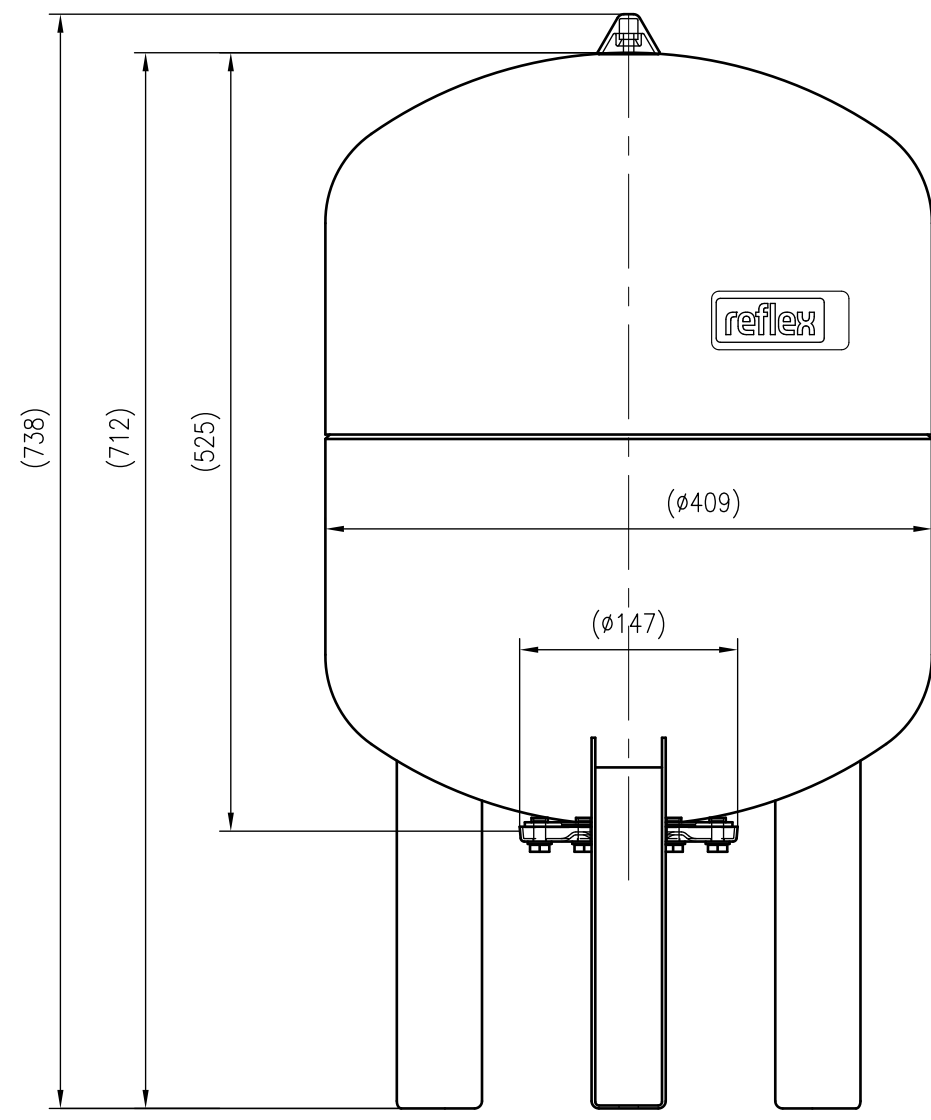

Front view

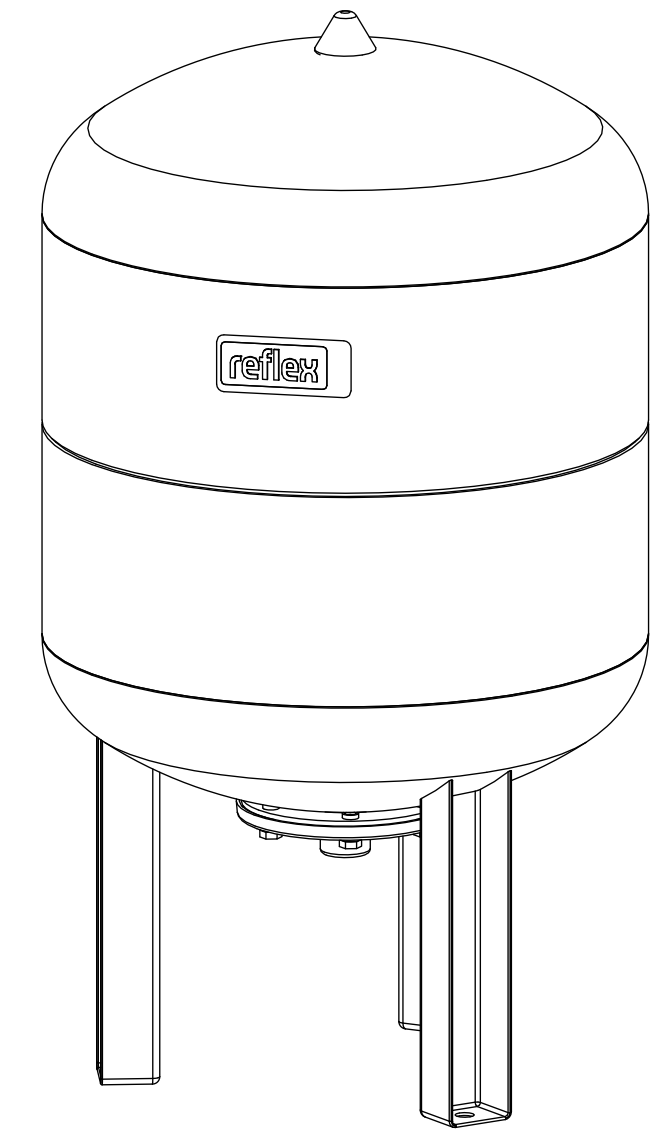

Isometric view

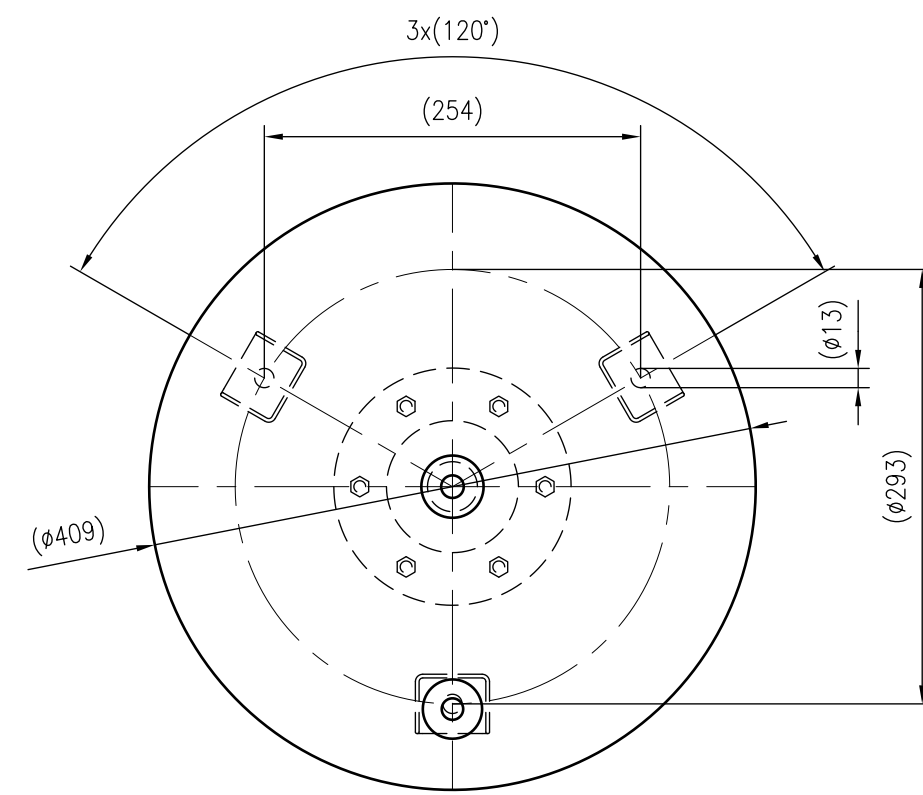

Top view



Unterliegt nicht dem Änderungsdienst/ Not subject to change management	Maßstab/ Scale: 1:5	Format/ Size: A2
Revision 21.06.2023	Refix DE 60 10bar – 7306400	