

Side view

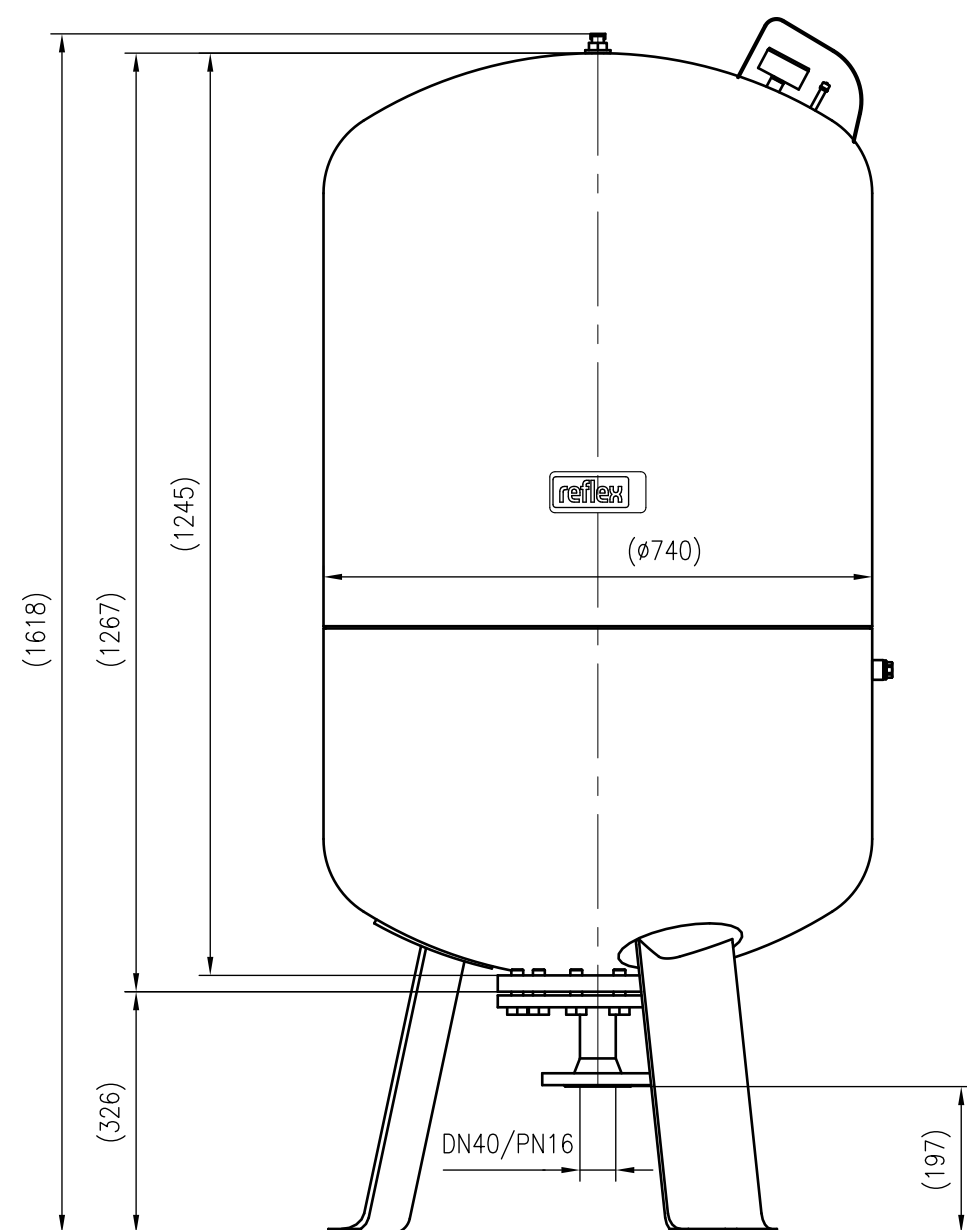

Front view

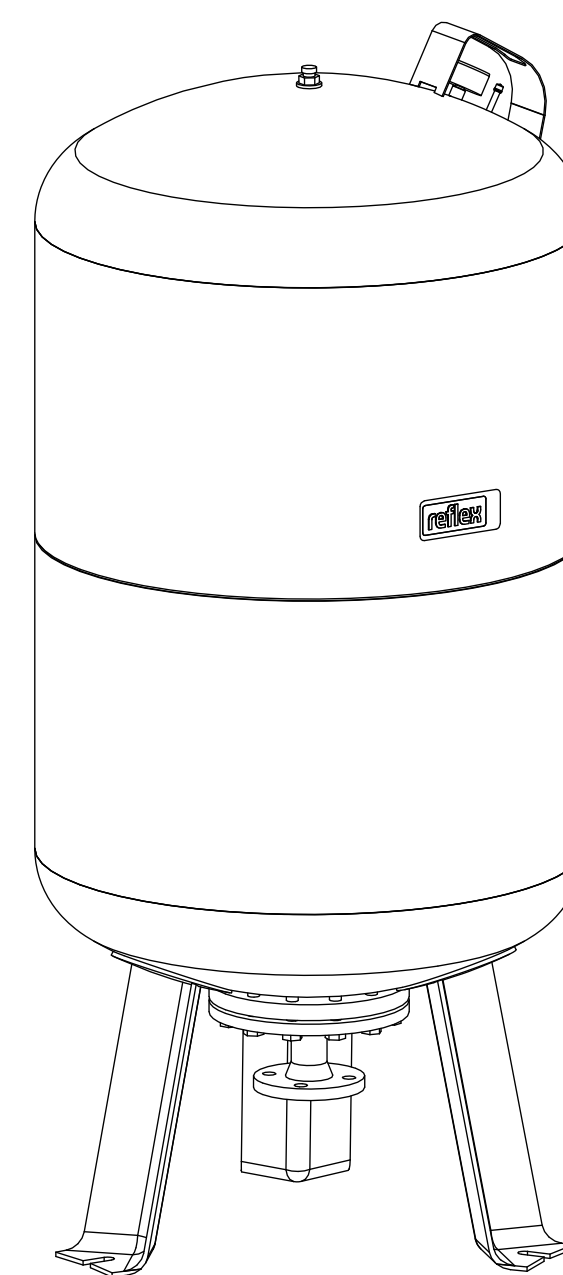

Isometric view

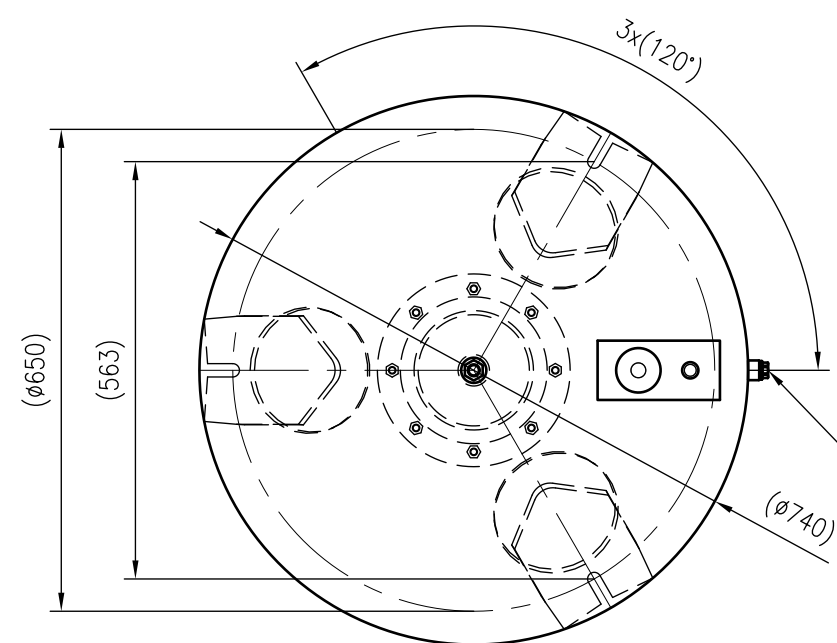

Top view

Optional auf Kundenwunsch mit  
Membranbruchmelder REF-006357  
Optional customizable with  
bladder rupture detector REF-006357



Unterliegt nicht dem Änderungsdienst/ Not subject to change management	Maßstab/ Scale: 1:10	Format/ Size: A2
Revision 28.08.2023	Reflex G500 16bar – 8518700	