

Side view

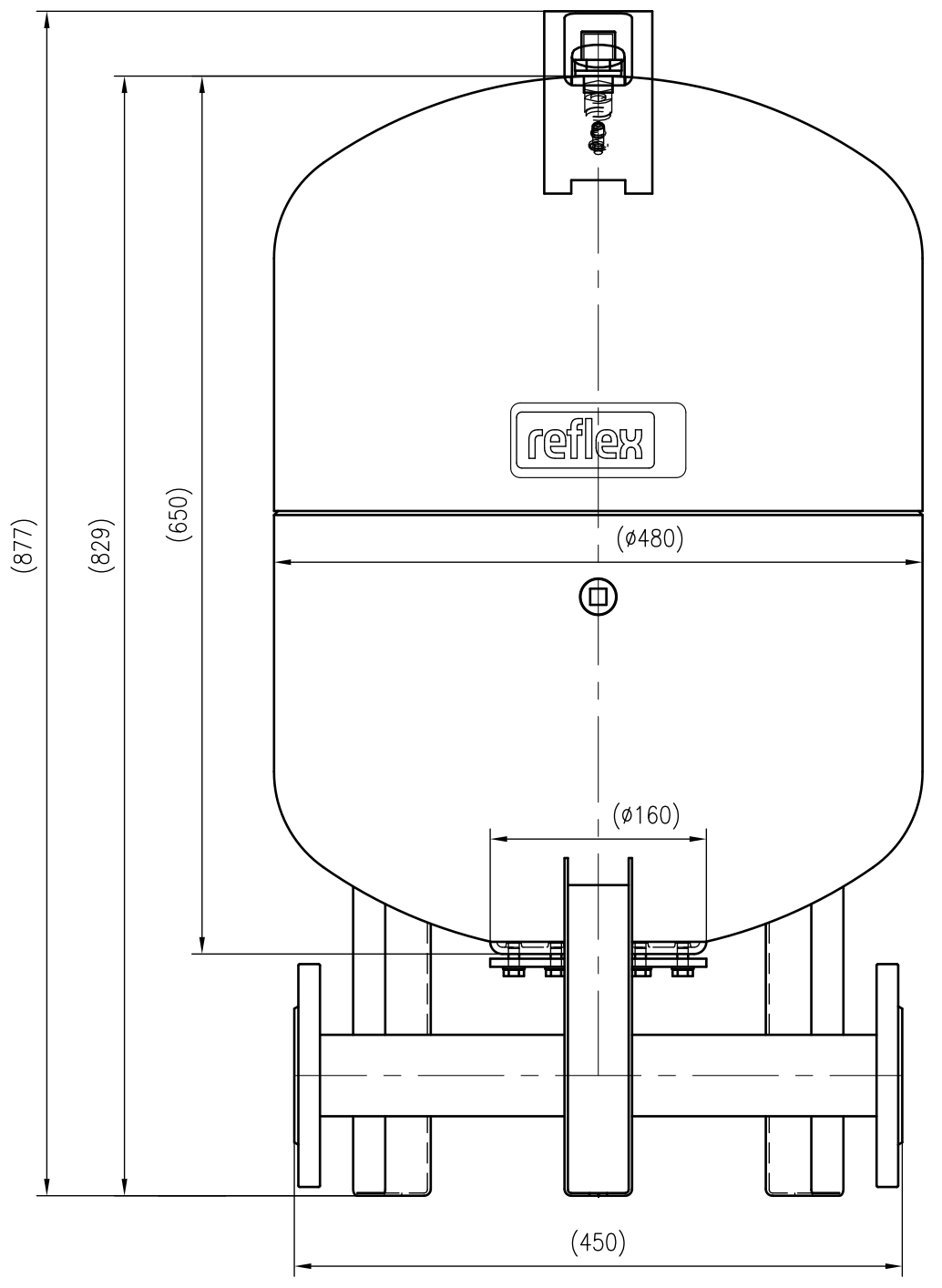

Front view

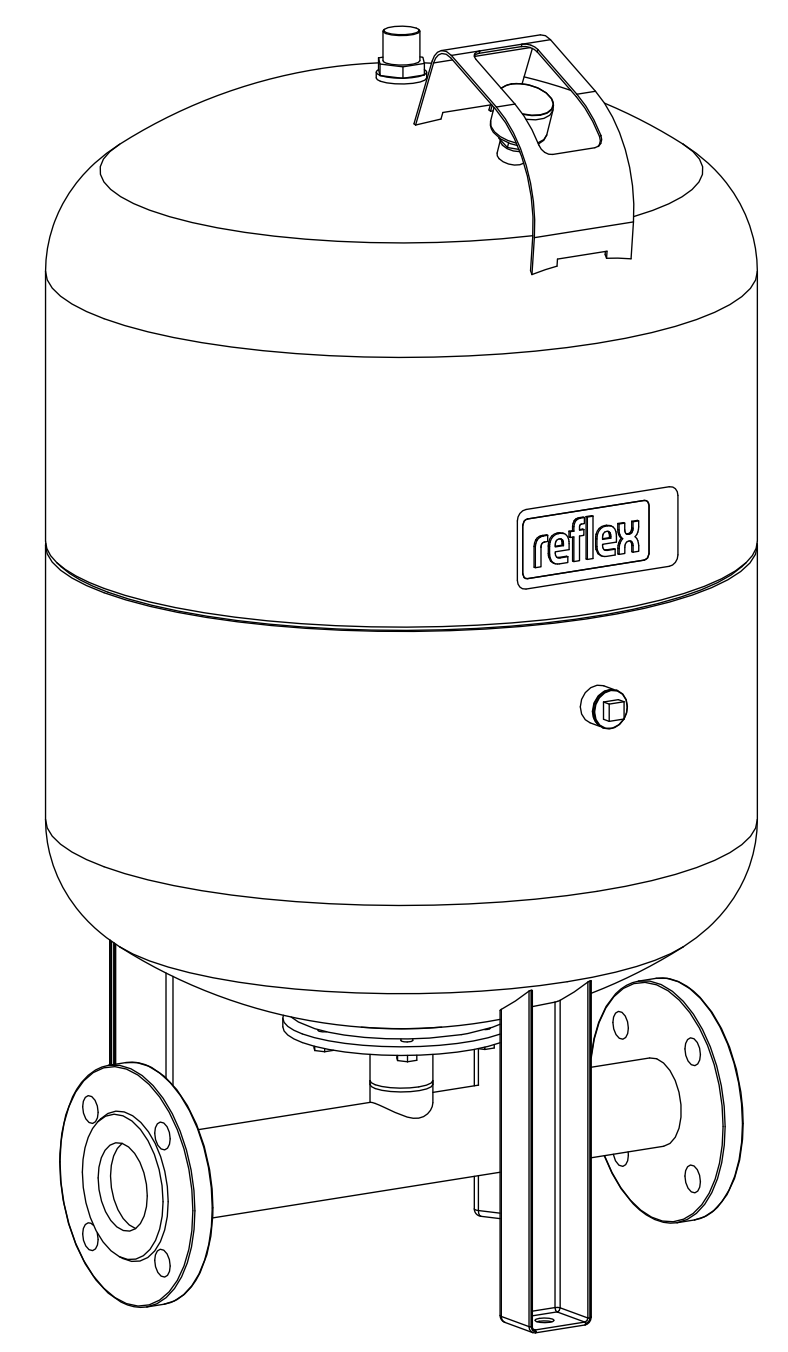

Isometric view

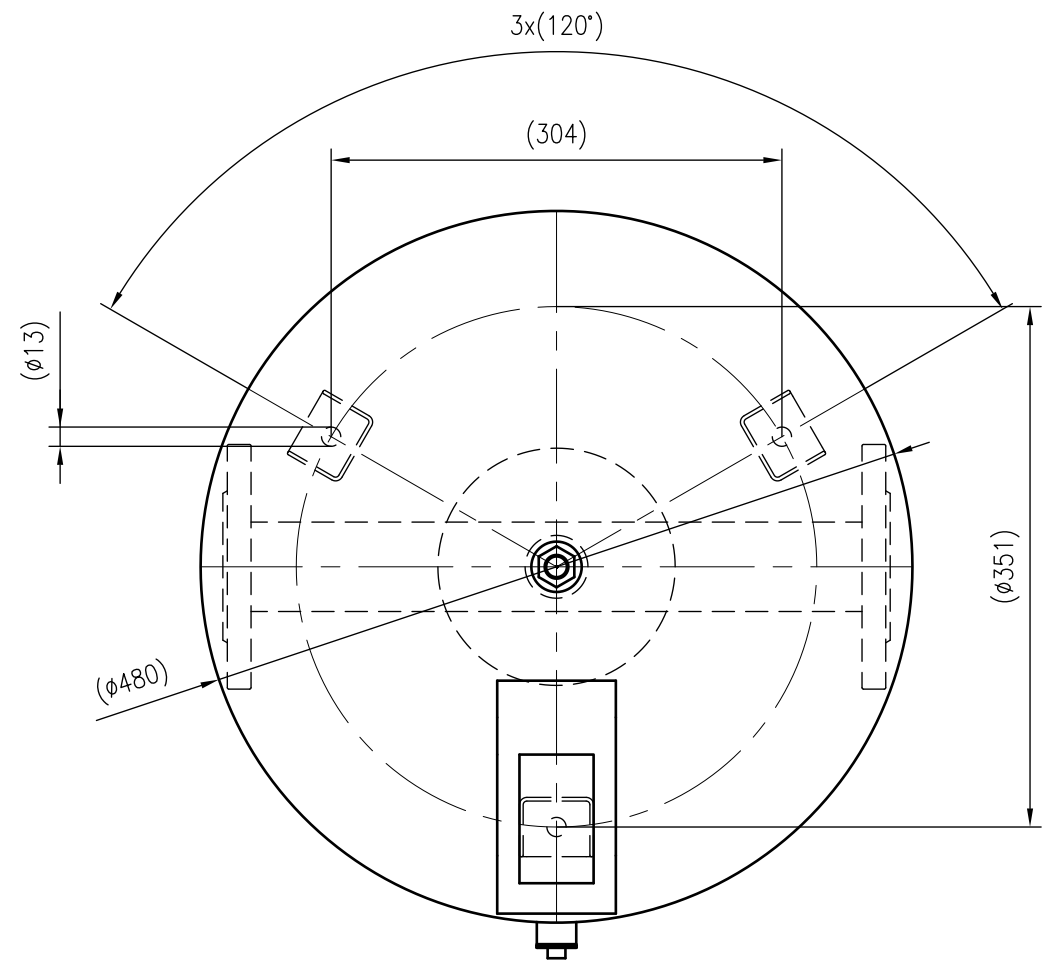

Top view



Unterliegt nicht dem Änderungsdienst/ Not subject to change management	Maßstab/ Scale: 1:5	Format/ Size: A2
Revision 11.07.2022	Reflex DT 100 10bar – 7365400	