

Side view

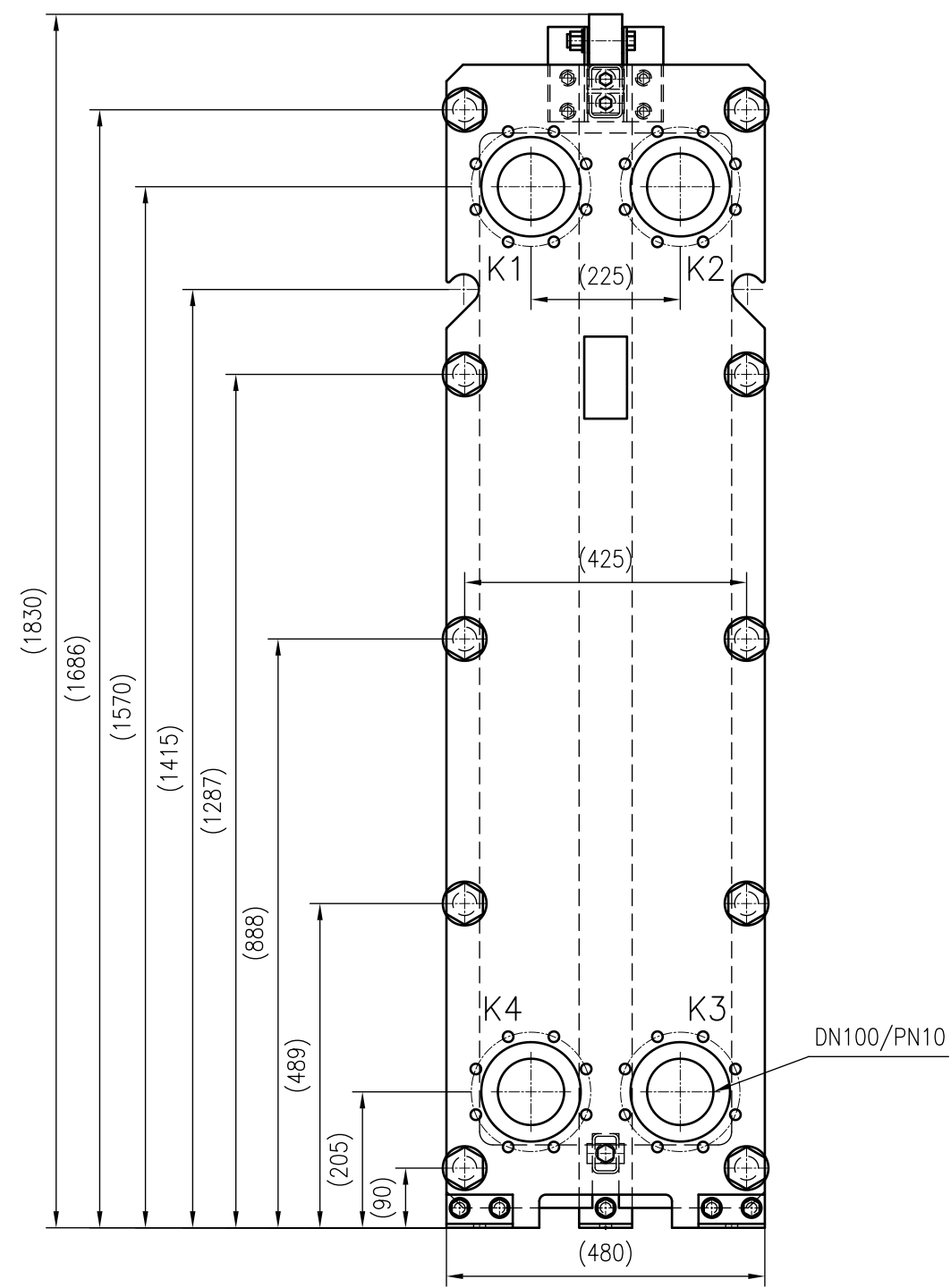

Front view

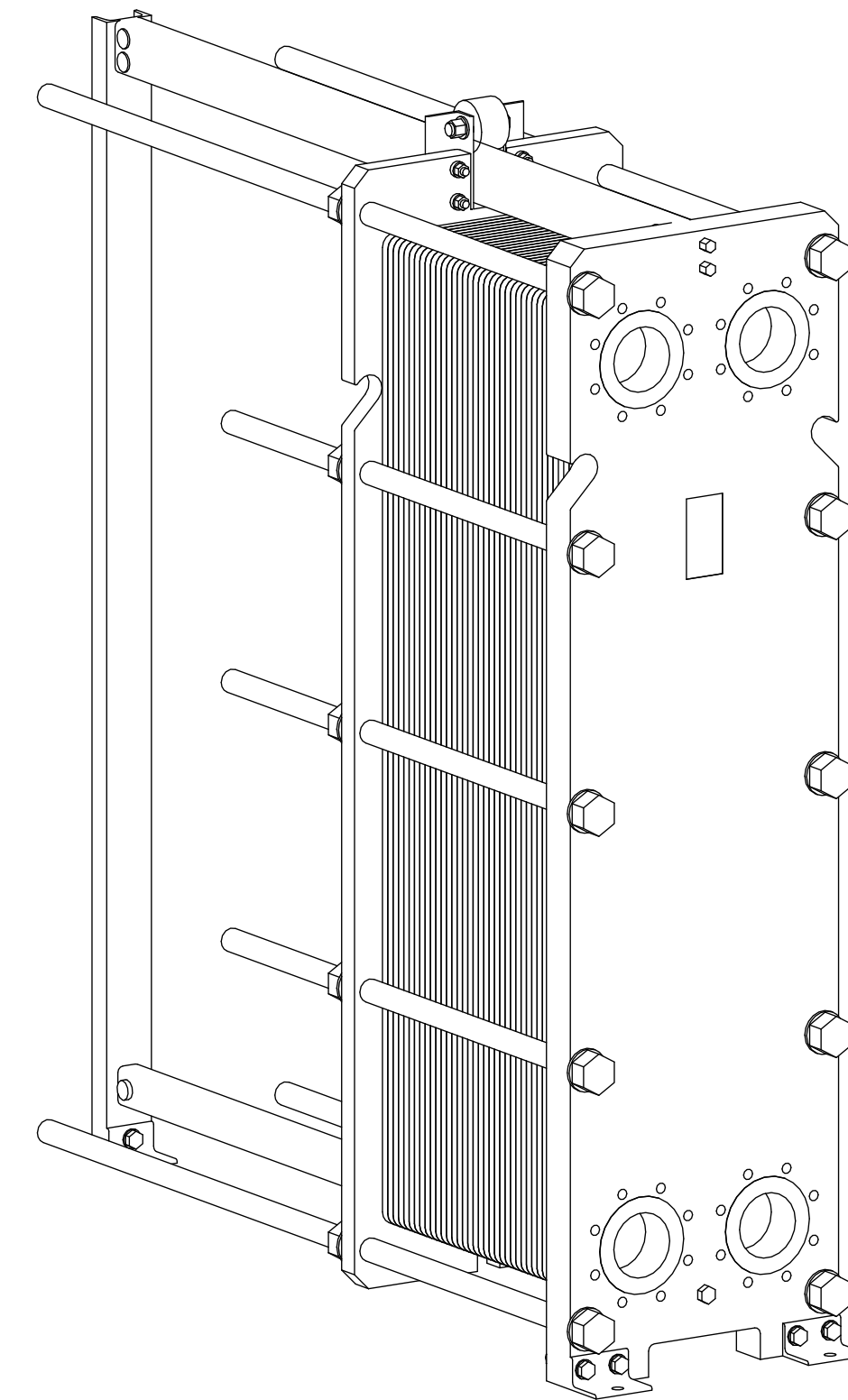

Isometric view

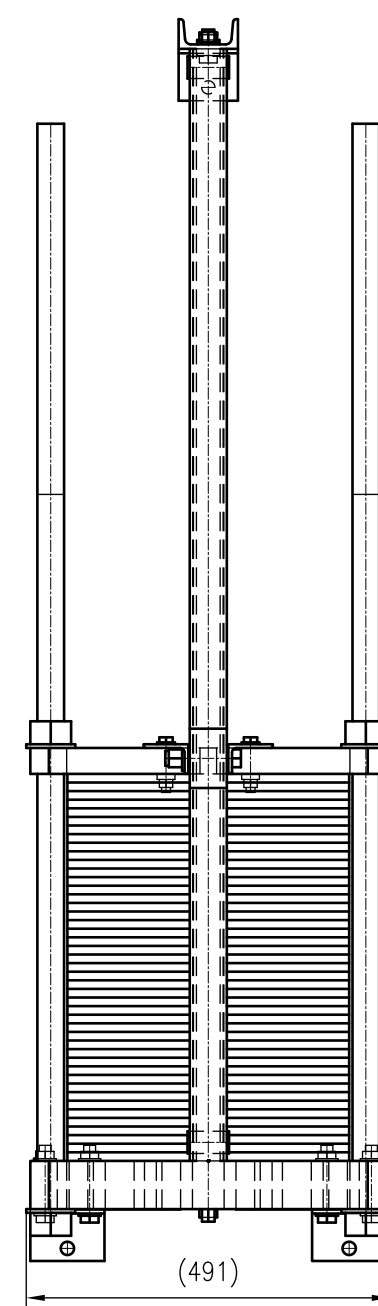

Top view



Unterliegt nicht dem Änderungsdienst/
Not subject to change management

Maßstab/
Scale: 1:10

Format/
Size: A2

Revision
02.09.2020

Longterm RLG-51-180-P10 - 8130200